



78-2883-250
6/16



Lionel LEGACY 360W PowerMaster Owner's Manual

A TMCC Command Base (6-12911), LEGACY Command Base (#992 from set 6-14295), or LEGACY BASE-1L (6-37156) is required to operate the LEGACY PowerMaster. The LEGACY PowerMaster is controlled by the signal generated by a Lionel command base. It is not controlled directly by the signals from a CAB controller.

Congratulations!

Congratulations on your purchase of the Lionel LEGACY 360W PowerMaster controller! This device is a high output control unit for use with any Lionel LEGACY or TMCC control system and external power supplies, providing your railroad with up to 360 watts and 20 amps of alternating current. The LEGACY 360W PowerMaster allows you to vary track voltage, change directions and operate whistle and bell sounds on your non-command locomotives using your TMCC or LEGACY Remote Controllers

Read this manual thoroughly before using your controller. It has important information on the setup and operation of this product. If you have any questions after reviewing these instructions, contact Lionel Customer Service.

Note! A TMCC Command Base (6-12911), LEGACY Command Base (#992 from set 6-14295), or LEGACY BASE-1L (6-37156) is required to operate the LEGACY PowerMaster. The LEGACY PowerMaster is controlled by the signal generated by a Lionel command base. It is not controlled directly by the signals from a CAB controller.

Table of contents

| | |
|---|-----|
| Safety information: Protecting your layout from overloads | 3 |
| LEGACY PowerMaster Features | 4 |
| Connecting your LEGACY PowerMaster to the track | 5 |
| Connecting your LEGACY PowerMaster to 0 gauge track | 5-6 |
| Connecting your LEGACY PowerMaster to a FasTrack terminal section | 7 |
| Supplying power to your LEGACY PowerMaster | 8 |
| Connecting your PowerMaster with 2 PowerHouse power supplies | 8 |
| LEGACY Control System set-up | 10 |
| Assigning a unique ENG or TR ID# to the LEGACY 360W PowerMaster output | 10 |
| Setting the device type and control mode for the PowerMaster with a CAB-2 Remote Control | 11 |
| TrainMaster Command Control operations | 12 |
| Operating TMCC-equipped locomotives with the PowerMaster | 13 |
| Operating Conventional locomotives in the Command Control environment using a CAB Remote Controller | 14 |
| LEGACY CAB-2 Remote Controller Commands | 15 |
| CAB-1 and CAB-1L Remote Controller commands | 16 |
| Running non-Lionel locomotives with your CAB-2/CAB-1 Remote Controller | 17 |
| Powering up for operation with MTH® Proto-Sound® 1.0 operations | 18 |
| Programming your QSI® M.T.H.® locomotive | 19 |
| Operating M.T.H.® Proto-Sound features with the LEGACY PowerMaster unit | 19 |
| Operating QSI® M.T.H.® Proto-Sound features with the LEGACY PowerMaster unit | 20 |
| Troubleshooting | 21 |
| FCC Statement | 22 |
| Notes | 23 |
| Lionel Limited Warranty Policy & Service | 24 |

Safety Information: Protecting your layout from overloads

Your LEGACY PowerMaster Controller provides a selectable output of 15 or 20 amps. The available voltage depends on how much load is on the output. Generally, the track voltage is 0-18 volts AC. This LEGACY PowerMaster Controller is capable of operating trains up to and including dual-motored AC engines.

To protect your controller and layout from damage caused by severe overloads and short circuits in the case of derailments or objects falling on the track, this controller is equipped with a fold-back current limit. It continuously monitors the output current. When there is an overload on the output, it will reduce the voltage on the output in a fraction of a second to hold the current at 15 or 20 amps. If the short circuit is not corrected in three seconds, the controller will interrupt power to the output. During the three seconds, the red light on the controller will flash. Once the output is shut down, the red light will come on solid. Press **AUX1, 0** on the CAB-1 Controller or reset on the CAB-2 Controller to reset the PowerMaster and resume normal operations. This electronic feature prevents the inconvenience of nuisance tripping caused by momentary overloads.

When using the PowerMaster with two 135W or two 180W PowerHouse Power Supplies, the circuit breaker on the PowerHouse Power Supply is designed as a fail-safe for the electronic over-current protection. Because most problems will be protected by and corrected during fold-back mode operation, the circuit breaker should trip infrequently. If the circuit breakers do trip, correct the short circuit (e.g., make sure that the train's wheels are properly on the track and remove any foreign objects from the rails), and then press the Circuit Breaker Reset buttons.

The following Lionel marks are used throughout this Owner's Manual and are protected under law. All rights reserved.

Lionel[®], LionChief[™], LionChief Plus[™], TMCC[®], LEGACY[®], FasTrack[®], TrainMaster[®], Odyssey[®], RailSounds[®], CrewTalk[™], TowerCom[™], DynaChuff[™], StationSounds[™], Pullmor[®], ElectroCoupler[™], Magne-Traction[®], CAB-1[®] Remote Controller, American Flyer[®], Lionel ZW[®], ZW[®], MagniVision[®], TMCC[®], Lionelville[®], Wireless Tether[™], Powerhouse[™], LionMaster[®], Conventional Classics[™], Postwar Celebration Series[™], TruRail[™], PH-1 Powerhouse[®], Powermaster[®], Powerstation-Powerhouse[®], Accessory Motor Controller[™], AMC[™], Accessory Switch Controller[™], ASC[™], Action Recorder Controller[™], ARC[™], Track Power Controller 300[™], TPC 300[™], Track Power Controller 400[™], TPC 400[™], Block Power Controller[™], BPC[™], Operating Track Controller[™], OTC[™], FatBoy[™], Lionel Lines[®], Joshua Lionel Cowen Series[™], Lockon[®], TrainSounds[™], MultiHorn[™], MultiWhistle[™], Choo-Choo[™], SensorTrack[™], Plug-Expand-Play[™], Imagineering[™]

LEGACY PowerMaster Features

Power Selection Switch

Slide the switch to the 270W position to set the electronic current limit to 270W or 15 amps when using two 135W PowerHouse transformers. Slide the switch to the 360W position to set the electronic current limit to 360W or 20 amps when using two 180W PowerHouse transformers.

A and U Power Output Terminals

Connect the A terminal to the middle rail of the track. Connect the U terminal to the outside rail of the track.

Transformer Jack

Power input connector from transformers.

Green Indicator - Power on indicator

Light will be on during normal operations. Light will flicker to indicate weak or absent command signal. Light will flash when setting the maximum output in CMD mode.

Red Indicator - Comm/Overload Indicator

Light will flash when receiving commands from the CAB controller or when the power limit has been exceeded. The light will come on if the output has been shut down due to an overload.

Program/Run Switch

Slide the switch to the PROG position to assign a unique TR or ENG ID#. Leave the switch in the RUN position for normal operation.

Command/Conventional Switch

Slide the switch to the CMD position to use the LEGACY PowerMaster as an ON/OFF switch to run command equipped locomotives. Leave the switch in the CONV position to run conventional locomotives.

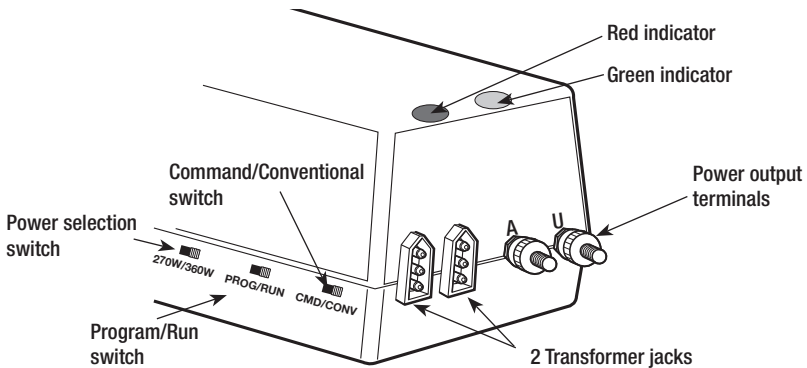

Figure 1. PowerMaster features

CAUTION! DO NOT MIX 135W AND 180W POWERHOUSES!
ONLY USE TWO POWERHOUSES WITH THE
SAME WATTAGES: 135W OR 180W.

Connecting your LEGACY PowerMaster to the track

For best performance on large layouts, it is recommended that you use 16-gauge wire to connect your PowerMaster to the track. Use the spade-shaped connectors on the PowerMaster with no more than two wires on each terminal. Use terminal strips (available at your local electronics supply store) to allow you to connect multiple wires to evenly distribute power to your layout.

Make sure that all connections are secure. Loose connections can produce extremely high temperatures. For this reason, do not touch the terminals or track connections during use. Also, do not locate scenery materials such as lichen or ground foam near the terminals.

Warning! To prevent the excessive build up of heat, be sure to select the proper wire gauge for your layout. Track connections (or Lockon connections) must be made with 16-gauge wire or heavier. Larger layouts require a minimum of 14-gauge wire.

Connecting your LEGACY PowerMaster to 0 gauge track

1. Attach the Lockon to the track.

As illustrated in Figure 2, slide the bottom edge of the outside rail into the metal lip on the Lockon. Press the clip at the end of the Lockon over the bottom edge of the inside rail.

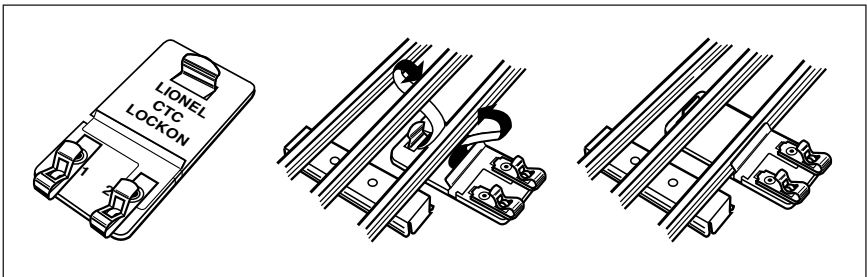

Figure 2. Lockon attachment

2. Attach one wire to the Lockon spring clip terminal labeled “1” and connect it to the power terminal labeled “A” on the PowerMaster. All Controller connections are illustrated in Figure 3 on page 6.

To attach the wire to the Lockon, press down on the top of the terminal clip so that the metal loop is exposed. Slide the bare end of the wire into the exposed loop. Release pressure on the terminal clip, allowing the metal clip to pinch the end of the wire in the metal loop. Give a little tug on the wire to check if the hold is secure.

3. Attach a second wire to the Lockon spring clip terminal labeled “2” and connect it to the transformer terminal labeled “U” on the PowerMaster.

Connecting your LEGACY PowerMaster to 0 gauge track (continued)

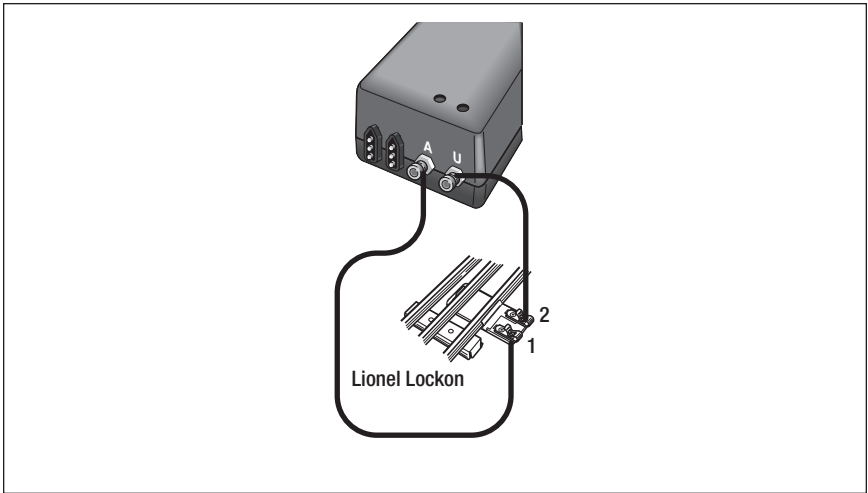

Figure 3. Transformer connection

Connecting your LEGACY PowerMaster to a FasTrack terminal section

If you are using the Lionel FasTrack track system, you will find that the terminal section easily connects to the PowerMaster's output terminals. Two wires are attached to the underside of the FasTrack terminal section (available separately, 6-12016). Attach the spade-shaped connectors at the ends of these wires to the PowerMaster. Be sure that the connections are secure. Follow these steps and refer to Figure 4.

Caution! If you are connecting the PowerMaster to your layout with any other type of wire, refer to the guidelines on page 5.

1. **Feed the wires through the notch in the FasTrack terminal section.** Refer to Figure 4.
2. **Loosen the “A” thumbscrew terminal, then slide the spade-shaped connector with the RED insulation at the end of the black wire with white tracer into position.** The thumbscrew post should be positioned between the “blades” of the spade connector. Tighten the thumbscrew to secure the connection.
3. **Loosen the “U” thumbscrew terminal, then slide the spade-shaped connector with the BLACK insulation at the end of the black wire into position.** Tighten the thumbscrew to secure the connection.

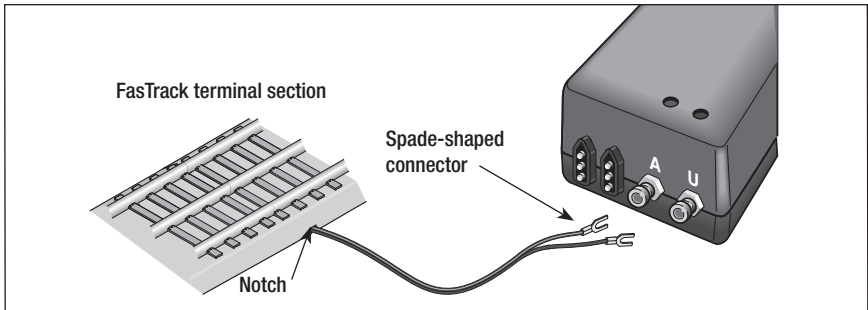

Figure 4. Transformer connections

Warning! To prevent excessive heat build up, always use at least two FasTrack terminal sections.

Supplying power to your LEGACY PowerMaster

The LEGACY PowerMaster receives its power from external power supplies. It has been designed to operate with two Lionel 135W PowerHouses (6-12866) or two 180W PowerHouses (6-22983).

CAUTION! DO NOT MIX 135W AND 180W POWERHOUSES! ONLY USE TWO POWERHOUSES WITH THE SAME WATTAGES: 135W OR 180W.

Connecting your PowerMaster to a PowerHouse power supply

1. Insert the PowerHouse power supply's connector plug into the 360W PowerMaster's connector jacks. Refer to figure 5 below.
2. On the PowerMaster, set the power selection switch to 270W if you are using two 135W PowerHouses or 360W if you are using two 180W PowerHouses.
3. Plug the two PowerHouses into a wall outlet (120 volts, 60 Hertz).

Note! Always switch off the PowerHouse Power Supply when you are not operating your railroad.

CAUTION! ALWAYS USE TWO POWERHOUSE POWER SUPPLIES. NEVER OPERATE WITH ONLY ONE POWERHOUSE.

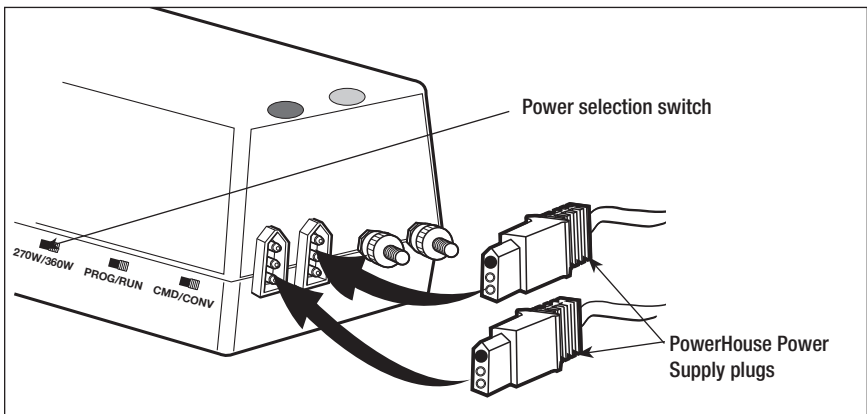

Figure 5. PowerMaster Installation

LEGACY Control System set-up

Before you operate the LEGACY 360W PowerMaster with the LEGACY Control System, you will need to set the device type, control mode, and assign it a unique ID#.

Note! The LEGACY 360W PowerMaster receives signals from the LEGACY 455 MHz track signal.

Assigning a unique ENG or TR ID# to the LEGACY PowerMaster output

1. Connect the “U” terminal of a LEGACY Command Base (#992 from set 6-14295) or a LEGACY BASE-1L (6-37156) to the “U” terminal of the PowerMaster or to the outside rail of the track.
2. Plug in the LEGACY Base and turn on the power to the LEGACY 360W PowerMaster.
3. Set the PROG/RUN switch on the PowerMaster to the PROG position.
4. Press **ENG** or **TR** on the CAB-2 Remote Control.
5. Enter the unique ID#. You may select any ENG ID# from **1** to **98** or any TR ID# from **1** to **99**.

Note! Version 1.4 LEGACY system update is required to use TR ID#s 10 to 95. Using these ID#s with LEGACY system Version 1.3 or lower will result in unexpected operation.

6. Press **SET**. The red light on the top of the PowerMaster will flash to indicate that the ID# has been set.
7. Slide the PROG/RUN switch back to the RUN position. The PowerMaster has now been assigned the ID# you selected.
8. Continue to the following section to set the device type and control mode

Setting the device type and control mode for the PowerMaster with a CAB-2 Remote Control

If the PowerMaster has been assigned an ENG ID# you will need to select a device type and control mode for the output so the CAB-2 Remote Controller knows how to operate the controller. You may also give the PowerMaster a name and a road number. If the PowerMaster has been assigned a TR ID# you will only need to set the control type.

If the PowerMaster is assigned an ENG ID#:

1. Assign a unique **ENG** ID#. Refer to page 10.
2. Press **ENG** on the CAB-2 Remote.
3. Enter the ID# assigned to the PowerMaster.
4. Press **INFO**.
5. Enter a name and road number for the PowerMaster if desired. Refer to the Legacy Control System manual for more information.
6. Press **SCROLL** to display the Type screen.
7. Select the device type
 - For LEGACY System with Version 1.4 update select XFMR.
 - For LEGACY System with Version 1.3 or lower select DSL.
8. Press **SCROLL** again to display the Control screen.
9. Select the control mode.
 - For LEGACY System with Version 1.4 update select CAB-1, TMCC or LEGACY.
 - For LEGACY System with Version 1.3 or lower select CAB-1.

Note! Using TMCC or LEG control modes with LEGACY system Version 1.3 or lower will result in unexpected operation.

10. Press **CTC** to exit.

If the PowerMaster is assigned an TR ID#:

1. Assign a unique **TR** ID#. Refer to page 11.
2. Press **TR** on the CAB-2 Remote Control.
3. Enter the ID#.
4. Press **INFO**.
5. Press **CLR**. Display will ask NAME & ENGINES?
6. Press **YES**.
6. Press **CTC** to exit.

TrainMaster Command Control operations

Before you operate the LEGACY PowerMaster with the TrainMaster Command Control System, you will need to assign a unique ID# to the PowerMaster.

Note! The LEGACY PowerMaster receives signals from the LEGACY 455 MHz track signal.

1. Connect the “U” terminal of a TrainMaster Command Control Base (6-12911) to the “U” terminal of the PowerMaster or to the outside rail of the track.
2. Plug in the TrainMaster Command Base and turn on the power to the PowerMaster.
3. Set the PROG/RUN switch on the PowerMaster to the PROG position.
4. Press **ENG** or **TR** on the CAB-1 or CAB-IL.
5. Enter the unique ID#. You may select any ENG ID# from 1 to 98 or any TR ID# from 1 to 9.
6. Press **SET**. The red light on the top of the PowerMaster will flash to indicate that the ID# has been set.
7. Slide the PROG/RUN switch back to the RUN position.

The PowerMaster has now been assigned the ID# you selected.

Operating TMCC-equipped locomotives with the PowerMaster

When operating Command-equipped locomotives with the PowerMaster, the PowerMaster serves as a circuit breaker and a remote power switch. In this mode the track power is either off or full on at the maximum output. The conventional bell, whistle, direction and other key activated functions of the LEGACY PowerMaster are disabled. The speed of the locomotive and all other locomotive features are controlled by addressing the locomotive directly.

1. Set the COMMAND/CONVENTIONAL switch to COMMAND.
2. Press **TR** or **ENG** and enter the unique ID number for the PowerMaster.
3. Press **BOOST** to set the track power to full on
4. Press **AUX1, 0** to turn off track power.

You may choose to limit the top speed of your locomotives by setting the maximum output voltage available from the LEGACY PowerMaster. To set a voltage limit:

1. Press the **SET** button on the CAB controller. The output voltage will drop to 0 and the green indicator will flash.
2. Use the **THROTTLE** knob on the CAB controller to set the output to the desired voltage.
3. Press the **SET** button again to lock in the voltage limit setting. The green indicator will stop flashing and come on to show that the setting has been saved.

Note! The voltage limit will be remembered even if the power to the PowerMaster is turned off.

Note! The voltage limit setting only applies when the Command/Conventional switch is the CMD position. It will not affect the maximum output voltage and cannot be set if the switch is in the CONV position.

Note! Setting the voltage limit too low may result in the undesirable operation of some locomotive functions (e.g., coil couplers, smoke units, sounds, etc.).

To clear the voltage limit setting:

1. Press the **SET** button twice without moving the Throttle knob. This will clear any previously set limits and allow the output of the LEGACY PowerMaster to go to the maximum available voltage.

Operating Conventional locomotives in the Command Control environment using a CAB Remote Controller

To operate Conventional locomotives, set the CMD/CONV switch on the LEGACY PowerMaster to CONV. When the switch is set to CONV, you have complete control of the PowerMaster output from the CAB Remote Control. You can set the output voltage to the track, trigger direction changes, and activate whistle and bell sounds. In addition, you can fire the ElectroCouplers on select conventional locomotives.

See the following pages for the key strokes used to activate the locomotive's features.

LEGACY CAB-2 Remote Controller Commands

Train Brake Slider
Adjust to set the limit for the maximum voltage from the output.
(LEGACY and TMCC mode)

0 or R buttons
Press to reset the output voltage to zero and reset an overload shutdown.

AUX-1/Thru Button
Press to view the Control Panel while operating.

Emergency Halt Button
Press to reset all LEGACY PowerMaster outputs and all Command Controlled equipment.

Velocity Throttle
Rotate clockwise to increase output voltage. Rotate counter-clockwise to decrease output voltage.

Set Button
Used to set ENG and TR addresses and to set maximum output in CMD mode.

Warning Sound Controller
Push up to trigger the bell on equipped locomotives. Pull down to trigger the whistle on equipped locomotives.

Boost
Rotate up to increase the output voltage while control is activated. Voltage returns to initial level when control is released.

Direction
Press to momentarily interrupt the output voltage to activate the reversing unit in conventional locomotives.

Brake
Rotate down to decrease the output voltage while control is activated. Voltage returns to initial level when control is released.

Front & Rear Coupler Buttons
Press to fire the front and rear ElectroCouplers on Conventional locomotives.

Speed Step Settings
The L, M and H buttons have different meanings depending on the previously set Control Mode assigned to the output.

CAB1 Control Mode Outputs
L 32 step mode output
M 100 step mode output
H 200 step mode output

TMCC Control Mode Outputs
L 32 step mode with LOW momentum
M 32 step mode with MEDIUM momentum.
H 32 step mode with HIGH momentum.

LEGACY Control Mode Outputs
L 200 step mode with LOW momentum, level 1
M 200 step mode with MEDIUM momentum, level 4 (Press and hold, then use the Velocity Throttle to select levels 1 through 8.)
H 200 step mode with HIGH momentum, level 8

CAB-1 and CAB-1L Remote Controller commands



Fires the rear ElectroCoupler on select Conventional locomotives.



Fires the front ElectroCoupler on select Conventional locomotives.



The **AUX1, 0** sequence sets the output voltage to zero and resets an overload shutdown.



Increases the output voltage with a clockwise rotation. Decreases the output voltage with a counter-clockwise rotation.



Triggers the whistle on equipped locomotives.



Triggers the bell on equipped locomotives.



Momentarily interrupts the output voltage to activate the reversing unit in the locomotive.



Increases the output voltage while button is pressed. Voltage returns to initial level when button is released.



Reduces the output voltage while button is pressed. Voltage returns to initial level when button is released.



Resets all LEGACY PowerMaster outputs to zero and resets all Command Controlled equipment.



Used to set ENG or TR addresses and to set maximum output in CMD mode



Speed Step Settings

- L** Sets the output to 32 speed step mode
- M** Sets the output to 100 speed step mode
- H** Sets the output to 200 speed step mode

Running non-Lionel locomotives with your CAB-2/CAB-1 Remote Controller

Your LEGACY PowerMaster Transformer was designed to be compatible with all locomotives operating on AC voltage from 0 to 18 volts. No modification of the locomotive is required.

If you experience erratic operation of some non-Lionel locomotives (such as random horn and bell sounds), placing a lighted car on the track or connecting an accessory to track power should eliminate the problem.

Powering up for operation with QSI®/M.T.H.® Proto-Sound® 1.0

Additional features have been added to the LEGACY PowerMaster unit to unlock the operation of the QSI®/M.T.H.® E units. The LEGACY PowerMaster unit makes M.T.H.® products operating in conventional mode compatible with the Lionel TrainMaster Command Control system!

Use your CAB Remote to power up the the track and control an M.T.H.® Proto-Sound® 1.0 locomotive.

1. Press **TR** or **ENG** on the CAB Remote.
2. Enter the ID# of the LEGACY PowerMaster unit into the numeric keypad on the CAB Remote.
3. Press **AUX1, 9** on the CAB Remote.

The power up sequence has been activated.

Caution! Do not press the **DIR** button; full power is applied to the track at this point.

4. After the engine sounds begin (or five seconds), enter the track voltage setting. Press **8** to supply 30% of full power.

Note! If you do not enter this number, your locomotive will take off as soon as you press the DIR button on the CAB Remote! If you accidentally start up the locomotive without selecting a voltage level (step 4), simply turn the power off and restart using this sequence.

5. Move 'em out! Press the DIR button on the CAB Remote.

Programming your QSI®/M.T.H.® Proto-Sound® 1.0 locomotive

The LEGACY PowerMaster allows you to program your QSI®/M.T.H.® Proto-Sound® 1.0 locomotives with ease, bringing some of the Proto-Sound® features under your control while operating in conventional mode. Follow these steps and refer to your locomotive's instructions for information about your engine's features.

1. Press **AUX1, 0** on the CAB Remote. Be sure to wait for the sounds to stop completely. This will reset the engine by completely removing power.
2. Press **AUX1, 9** on the CAB Remote. Track voltage goes to full.
3. Press **5** repeatedly on the numeric keypad until the desired feature is activated. A programming pulse is sent through the track to program the QSI®/M.T.H.® Proto-Sound® 1.0 units.

Note! Do not press the **AUX1** button on your CAB Remote between pressing **9** and **5**.























4. Press the **WHISTLE** button on the CAB Remote to program that feature. Consult your M.T.H.® engine operating instructions for specific details.

Operating M.T.H.® Proto-Sound® 2.0 features with the LEGACY PowerMaster unit

The LEGACY PowerMaster allows you to operate M.T.H.® Proto-Sound® 2.0 locomotives in conventional mode. At the press of a few buttons, your favorite conventional Proto-Sound® 2.0 features—like speed control and coupler operation—are at your command.

Note! All M.T.H.® Proto-Sound® 2.0 features can be accessed in conventional mode. Refer to the next section for additional information.

Operating QSI®/M.T.H.® Proto-Sound® features with LEGACY PowerMaster

-   Turns track power off.
(used with Proto-Sound® 1.0 and 2.0)
-   M.T.H.® Station Talk.
(used with Proto-Sound® 2.0)
-   M.T.H.® Fast Horn.
(used with Proto-Sound® 2.0)
-   M.T.H.® Programming Pulse.
(used with Proto-Sound® 1.0)
-   M.T.H.® Fast Bell.
(used with Proto-Sound® 2.0)
-   Places track voltage at 30% of input.
(used with Proto-Sound® 1.0)
-   Places full voltage on the track. Start up
sequence for M.T.H.® Proto-Sound® 1.0.
-   M.T.H.® Speed control toggle ON/OFF.
(used with Proto-Sound® 2.0)
-   M.T.H.® Reset to factory defaults.
(used with Proto-Sound® 2.0)
-    M.T.H.® Lock direction toggle ON/OFF.
(used with Proto-Sound® 2.0)
-  M.T.H.® Opens front coupler.
(used with Proto-Sound® 2.0)
-  M.T.H.® Opens rear coupler.
(used with Proto-Sound® 2.0)

Troubleshooting

No lights or operation

Be sure that the PowerHouse power supply is plugged into the LEGACY PowerMaster, the PowerHouse cord is plugged into a 120 VAC outlet, and the power switch is turned on.

Train runs, but WHISTLE/HORN, BELL, and DIRECTION buttons do not work

Check track connections. The track must be connected to the “A” and “U” terminals on the transformer. Check that the CMD/CONV switch is in the CONV position.

Locomotive runs slowly or lights dim at the far end of the track

On larger layouts, additional track resistance may cause a voltage drop. Attach additional Lockons to the remote portion of your track.

Red indicator light is flashing or on

The power limit of the transformer has been exceeded. The unit will gradually reduce power until the problem is corrected. Light will remain On when output is shutdown due to an overload. Press **AUX1**, **O** or **R** on the CAB remote to reset the PowerMaster.

Bell button blows whistle

Switch the wire connections at the Lockon or PowerMaster Terminals. Be sure that the U post is connected to the outside rail and the A post is connected to the inside rail.

Green indicator light is flickering

The Command signal is weak or absent. Check that the Command Base is plugged in and the green light is on. Ensure that the U terminal of the Command Base is connected to the U terminal on the LEGACY PowerMaster or to the outside rail of the track.

The PowerMaster does not respond to the CAB Remote Controller

Check to see that the Command Base is plugged in and the green light is on. Ensure that a wire is connected between the Command Base “U” terminal and the LEGACY PowerMaster U terminal (or to the U terminal on a track Lock-On). Turn the power off to the LEGACY PowerMaster and then back on. Check the batteries in CAB Remote Controller. Reprogram the ID# of the LEGACY PowerMaster.

Output does not go to full voltage in CMD mode

Maximum output voltage for CMD mode has been set. Clear the setting.

Cannot set a voltage limit in CMD mode

Check that the command/conventional switch is in the CMD position.

FCC Statement

Warning: Changes or modifications to this unit not expressly approved by the party responsible for compliance could void the user authority to operate the equipment.

.....

Notes: This equipment has been tested and found to comply with the limits for a Class B digital device, pursuant to Part 15 of the FCC Rules. These limits are designed to provide reasonable protection against harmful interference in a residential installation. This equipment generates, uses and can radiate radio frequency energy and, if not installed and used in accordance with the instructions, may cause harmful interference to radio communications.

However, there is no guarantee that interference will not occur in a particular installation. If this equipment does cause harmful interference to radio or television reception, which can be determined by turning the equipment off and on, the user is encouraged to correct the interference by one or more of the following measures:

- Reorient or relocate the receiving antenna.
- Increase the separation between the equipment and receiver.
- Connect the equipment into an outlet on a circuit different from that to which the receiver is connected.
- Consult the dealer or an experienced radio/TV technician for help.

Lionel Limited Warranty Policy & Service

This Lionel product, including all mechanical and electrical components, moving parts, motors and structural components, with the exception of **LIGHT BULBS, LED's & TRACTION TIRES** are warranted to the original owner-purchaser for a period of **one year from the original date of purchase** against original defects in materials or workmanship when purchased through a **Lionel Authorized Retailer***.

This warranty does **NOT** cover the following:

- Normal wear and tear
- Light bulbs or LED's
- Defects appearing in the course of commercial use
- Damage resulting from abuse/misuse of the product

Transfer of this product by the original owner-purchaser to another person voids this warranty in its entirety. Modification of this product in any way; visually, mechanically or electronically, voids the warranty in its entirety.

Any warranted product which is defective in original materials or workmanship and is delivered by the **original owner-purchaser** (this warranty is non-transferrable) to Lionel LLC or any Lionel Authorized Service Station **MUST** be accompanied by the original receipt for purchase (or copy) from an **Authorized Lionel Retailer***, will at the discretion of Lionel LLC, be repaired or replaced, without charge for parts or labor. In the event the defective product cannot be repaired, and a suitable replacement is not available, Lionel will offer to replace the product with a comparable model (**determined by Lionel LLC**), if available. In the event a comparable model is not available the customer will be refunded the original purchase price (requires proof of purchase from the **Authorized Lionel Retailer*** it was originally purchased). Any products on which warranty service is sought must be sent freight or postage prepaid (Lionel will refuse any package when postage is due). **Transportation and shipping charges are not covered as part of this warranty.**

NOTE: Products that require service that do not have a receipt from a LIONEL AUTHORIZED RETAILER* will be required to pay for all parts required to repair the product (labor will not incur a charge) providing the product is not older than 3 years from date of manufacture and is within 1 year from date of purchase. A copy of the original sales receipt is required.

In no event shall Lionel LLC be held liable for incidental or consequential damages.

Some states do not allow the exclusion or limitation of incidental or consequential damages, so the above exclusion may not apply to you. This warranty gives you specific legal rights and you may have other rights which vary from state to state.

Instructions for Obtaining Service

If service for this Lionel LLC product is required, bring the item, along with your DATED sales receipt and completed warranty information (at the bottom of this page) to the nearest Lionel Authorized Service Station. Your nearest Lionel Service Station can be found by calling 1-800-4-LIONEL or by accessing the website at www.lionel.com.

If you prefer to send your Lionel product directly to Lionel, for repair you must FIRST call 586-949-4100 extension 2 or write to Lionel Customer Service, 6000 Victory Lane, Concord, NC 28027. Please have the 6-digit Lionel product number, the date of original purchase, the dealer where the item was purchased and what seems to be the problem. You will receive a return authorization (RA) number to ensure your merchandise will be properly tracked and handled upon receipt at Lionel LLC.

Once you have your Return Authorization (RA) number, make sure the item is packed in its original Styrofoam inner container which is placed inside the original outer display box (this will help prevent damage during shipping and handling). This shipment **MUST** be prepaid and we recommend that it be insured with the carrier of your choice.

Please make sure you have followed all of the above instructions carefully before returning any merchandise for service. You may choose to have your product repaired by one of Lionel LLC's Authorized Service Stations after its warranty has expired. A reasonable service fee should be expected once the product warranty has expired.

Warranty Information

Please complete the information below and keep it, along with your **DATED ORIGINAL SALES RECEIPT**. You **MUST** present this form **AND** your **DATED SALES RECEIPT** when requesting warranty service.

*A complete listing of Lionel Authorized retailers can be found by calling 1-800-4-LIONEL or by visiting our website at www.lionel.com.

Products that are more than 3 years old, from date of manufacture, are not applicable for warranty coverage, even if they have never been sold prior to this date. (Under no circumstance shall any components or labor be provided free of charge.)

Name _____

Address _____

Place of Purchase _____

Date of Purchase _____

Product Number _____



©2016 LIONEL L.L.C.
6301 Performance Dr., CONCORD, NC 28027
UNITED STATES OF AMERICA
PRINTED IN CHINA