

10932010250
10/19



Lionel LionChief Plus 2.0 2-8-4 Steam Locomotive Owner's Manual



Thank You!

Thank you for your purchase of this Lionel steam locomotive! On the outside, this locomotive features numerous details and expert decoration in your favorite livery. Inside the boiler and tender, this locomotive is equipped with some of the most advanced sounds and controls in model railroading. This powerful locomotive is ready for duty on your layout.

FCC Statement

This device complies with part 15 of the FCC Rules and with Industry Canada license-exempt RSS standard(s). Operation is subject to the following two conditions: (1) This device may not cause harmful interference, and (2) this device must accept any interference received, including interference that may cause undesired operation.

Contains

P/N: WJ-M101L

FCC ID: LIV-BLEMOD1

IC: 7032A-BLEMOD1



LionChief® Plus 2.0

A step-up from our traditional set locomotives, these locomotives include improved sounds, additional light and smoke features, speed control and the ability to be run via conventional transformer or TMCC Command Control in addition to Bluetooth.



ODYSSEY II® Speed Control

Slow speed and start-up operation are smooth and steady with ODYSSEY II® Speed Control. Watch your locomotive as it creeps through the yard or fights up a grade without hesitation.



LionChief® Bluetooth®

Incorporating Bluetooth technology into Lionel model trains opens a new world, integrating the tradition of model railroading with the latest smart-device technology. With Lionel's new LionChief app, you can control full operation and sounds directly from your Bluetooth-enabled smart phone or tablet and operate multiple locomotives from the same device. LionChief is available to smartphone users and is compatible with all new 2017 LionChief, LionChief Plus, S-Gauge, and HO Trains.

The Bluetooth® word mark and logos are registered trademarks owned by the Bluetooth SIG, Inc. and any use of such marks by Lionel is under license. Other trademarks and trade names are those of their respective owners.

Apple and the Apple logo are trademarks of Apple Inc., registered in the U.S. and other countries. Mac App Store is a service mark of Apple Inc.

Google Play and the Google Play logo are trademarks of Google Inc.

The following Lionel marks are used throughout this Owner's Manual and are protected under law. All rights reserved.

Lionel®, *LionChief®*, *LionChief Plus®*, *FlyerChief®*, *TMCC®*, *LEGACY®*, *FasTrack®*, *TrainMaster®*, *Odyssey®*, *RailSounds®*, *CrewTalk™*, *TowerCom™*, *ElectroCoupler™*, *CAB-1® Remote Controller*, *TMCC®*, *Wireless Tether™*, *SensorTrack™*, *LionMaster®*

Table of Contents

Running your locomotive

LEGACY controller operations	4-5
TrainMaster Command Control (TMCC/Command Control) operations	6
Conventional transformer operations	7

Locomotive basics

Adding smoke fluid to your locomotive's smoke generator	8
Locomotive switch locations	8
Assigning your locomotive a new ID# (LEGACY and TMCC)	9

LEGACY controller operations

The LEGACY CAB-2 Remote Controller	10
The Velocity Throttle	11
The Multi-Controller	11
The Train Brake Slider	11
The Warning Sound Controller	12
The Speed Bar	12

RailSounds Sound System operations

RailSounds sound system	13
-------------------------	----

Using the Bluetooth LionChief App

Connecting to your LionChief, LionChief Plus, LionChief Plus 2.0, FlyerChief, or Legacy locomotive	14
What if my Bluetooth enabled engine didn't automatically connect?	14
Connecting to your LionChief, LionChief Plus, LionChief Plus 2.0, or FlyerChief locomotive on Android devices	15
Running Your Locomotive	16
Settings	17
Volume Control	17
Switching Connection Between Multiple Bluetooth® Locomotives	18
Troubleshooting	18

Using the LionChief Universal Remote

The LionChief Universal Remote (6-83071)	19-20
Adjusting the locomotive volume using the Universal Remote	21
Pairing locomotives to the Universal Remote	21
Operating locomotives with the Universal Remote	22-23

TrainMaster Command Control operations

CAB-1 Remote Controller commands	24
CAB-1 Remote Controller numeric keypad commands	25-26
Setting the smoke level	26
Customizable Whistle and Bell Feature	27

Conventional transformer operations

Using the RailSounds sound system in the conventional environment	27
Activating CrewTalk dialog	27
Locking your locomotive into a single direction	28
Reprogramming your locomotive to restore features	28

Maintaining and servicing your locomotive

Lubricating your locomotive	29-30
Servicing your locomotive's LEDs	30
Maintaining your locomotive's handrail antennas	31
Replacing the traction tires	31
Locomotive diagnostics	31
Lionel Limited Warranty Policy & Service	32

Running your locomotive

Note! Your LionChief Plus 2.0 locomotive requires Lionel or Lionel-compatible 0-31 or larger track curves.

LEGACY controller operations

Your LionChief Plus 2.0 locomotive is compatible for operation with the Lionel LEGACY system. It will also operate on the original Lionel TrainMaster System (TMCC1) and also on the LEGACY Cab-1L / Base-1L operating system.

Your commands are sent by the Remote Controller to the Command Base, which broadcasts a radio frequency that is distributed through the outer rails of the track to your locomotives. Your locomotive will not respond until it recognizes its unique ID#, so you can operate multiple Command-equipped locomotives on the same track at the same time.

1. Turn off track power, and then plug in the LEGACY Base and connect it to the track.
2. Place your locomotive and tender on the track and connect the drawbar as shown in Figure 1.

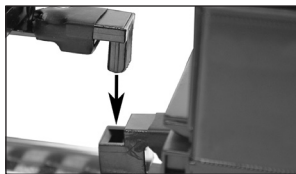

Figure 1. Drawbar connection

3. Increase track power voltage to full power (no more than 19 volts AC). If a circuit breaker trips when you turn on the Lionel power supply, check the wheels of your locomotive to make sure they are all securely on the track. Check to make sure the track is free of all metals that may cause a short circuit.
4. As illustrated in Figure 2, press **ENG** and **1** (or your selected ENG ID#) to address the locomotive with your LEGACY CAB-2 Remote Controller.

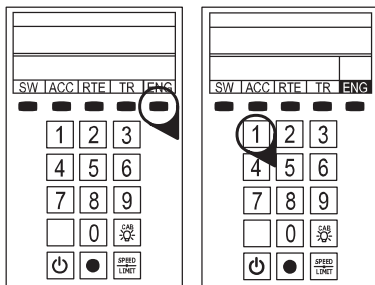

Figure 2. LEGACY engine selection

Running your locomotive

LEGACY Control operations continued

5. After selecting the ENG ID# on the Cab 2 remote, your remote needs to be configured for TMCC or CAB1 control for the locomotive. Select the engine ID# of your LC+ 2.0 engine as before, then press the INFO button on the top right of your CAB-2 remote.



Figure 3. CAB-2 info button

Press the SCROLL button on the top left of the CAB-2 row until the CONTROL tab is selected. Press the button that corresponds to the TMCC or CAB1 Mode selection on the screen. Congratulations! You have now configured your CAB-2 remote to run your LC+ 2.0 locomotive in TMCC mode. Enjoy all the features your locomotive has to offer.

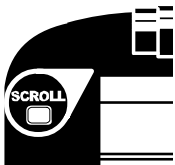

Figure 4a. CAB-2 scroll button

ENGINE 1 INFO			
Custom	Type OTH	Control TMCC	Sound LRS
LIONEL TMCC			
CAB1 TMCC LEG			

Figure 4b. CAB-2 control screen

6. Press the Start Up key on your LEGACY CAB-2 Remote, shown in Figure 5. Then, throttle up and move 'em out! Your engine sound will start up, and the locomotive-specific touch screen buttons will populate the remote. For more information on operating your locomotive with the LEGACY system, please refer to the LEGACY section of this manual. Additional information is also found in the LEGACY System Manual, available online at www.lionel.com.

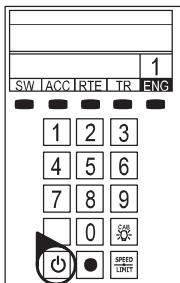

Figure 5. LEGACY start-up

Running your locomotive

Note! Your LionChief Plus 2.0 locomotive requires Lionel or Lionel-compatible 0-31 or larger track curves.

TrainMaster Command Control (TMCC/Command Control) operations

For operation in the TrainMaster Command Control environment, you need a TrainMaster Command Base (6-12911) and a CAB-1 Remote Controller (6-12868). Refer to your TMCC System Manual for complete information.

Your commands are sent by the CAB-1 Remote Controller to the Command Base, which translates the command into digital code. That code is sent through the outside rails to your locomotive, which will not respond until it recognizes its unique ID#. TrainMaster Command Control gives you the power to operate multiple Command-equipped locomotives on the same track at the same time.

- 1. Turn off track power, and then plug in the Command Base and connect it to the track.**
- 2. Place your locomotive and tender on the track and connect the drawbar as shown in Figure 1 on page 4.**
- 3. Increase track voltage to full power (no more than 19 volts AC).** If a circuit breaker trips when you turn on the Lionel power supply, check the wheels of your locomotive to make sure they are all securely on the track. Check to make sure the track is free of all metals that may cause a short circuit.
- 4. Press ENG and 1 to address your locomotive with your CAB-1 Remote Controller.**
- 5. Throttle up and move 'em out.**

For more information, please refer to the TrainMaster Command Control operations section of this manual or the TMCC System Manual, available online at www.lionel.com.

Running your locomotive

Conventional transformer operations

Note! For Conventional operation, a Command Base must **not be powered up anywhere in the area**, even if it is not connected to the track. If a base is detected, your locomotive will default to Command mode.

Note! Your LionChief Plus 2.0 locomotive requires Lionel or Lionel-compatible 0-31 or larger track curves.

Note! To access ALL of the features of your LionChief Plus 2.0 locomotive you must operate in the TMCC environment as described on page 5.

- 1. With track power off, place your locomotive and tender on the track. Connect the drawbar as shown in Figure 1 on page 4.**
- 2. Power up the track.** If a circuit breaker trips when you turn on the Lionel power supply, check the wheels of your locomotive to make sure they are all securely on the track. Check to make sure the track is free of all metals that may cause a short circuit.
- 3. Move 'em out!** When the locomotive's headlight illuminates and the LEGACY RailSounds sound system starts, press the DIRECTION button on your transformer to sequence your locomotive through the repeating pattern of operations: neutral, forward, neutral, reverse, neutral, and so on. You may also briefly turn off track power to advance the locomotive to the next operating state. Adjust the throttle until your locomotive moves at your desired speed.

When placing your locomotive on your layout for the first time and after power interruptions lasting longer than five seconds, it will start out in neutral.

Note! Use the **Whistle** and **BELL** buttons on your transformer to activate those features. For more information, please refer to the Conventional transformer operations section of this manual.

Note! If your locomotive is running in Conventional mode, it can be interrupted by a Bluetooth Control device. If you do not wish for this to happen, locate the Bluetooth ON/OFF switch and move it to the OFF position. Refer to Figure 7 on page 8.

Adding fluid to your locomotive's smoke generator

Your LionChief Plus 2.0 locomotive is equipped with a smoke generator that produces safe, clean, white smoke during operation. The smoke generator for this locomotive supplies the stack smoke effect. The reservoir contains the fluid and wick which, once saturated, supplies the heating element with the right amount of fluid.

Note! For best performance, we recommend using only 6-37841 Lionel Premium Smoke Fluid.

Locomotive basics

Adding fluid to your locomotive's smoke generator continued

Stack Smoke

Loading smoke fluid **into the smoke stack** will provide smoke fluid for the stack smoke effect. **When adding fluid DO NOT EXCEED 20 DROPS per unit** as this can cause your smoke unit to become oversaturated allowing leakage onto the electronics. Note that operating your locomotive's smoke unit without smoke fluid will cause damage to the heating element. Add 20 drops initially and 10 to 20 thereafter, as required to maintain desired smoke.



Figure 6. Stack smoke location

Note! Your locomotive's smoke fluid consumption will vary depending on the smoke level setting you have selected.

Refer to Figure 6 as you add the smoke fluid. If you prefer to operate your locomotive without smoke, locate the smoke unit switch under the cab of the locomotive and slide it to the OFF position. Refer below for the location of the switch.

Locomotive switch locations

The functions of your LionChief Plus 2.0 locomotive's switches are outlined below. *The instructions below are specific to this particular locomotive; note that available features (and switches) may differ from other locomotives and sets.*

Smoke Switch

Used to turn the smoke unit on and off.

Program / Run Switch

Used to assign an ID# and reprogram the locomotive in Command operation when the switch is in the PROG position. Also used to “lock” your locomotive in a single direction, or neutral, in conventional operation when the switch is placed in the PROG position.

Bluetooth Switch

Used to turn the Bluetooth module on and off.

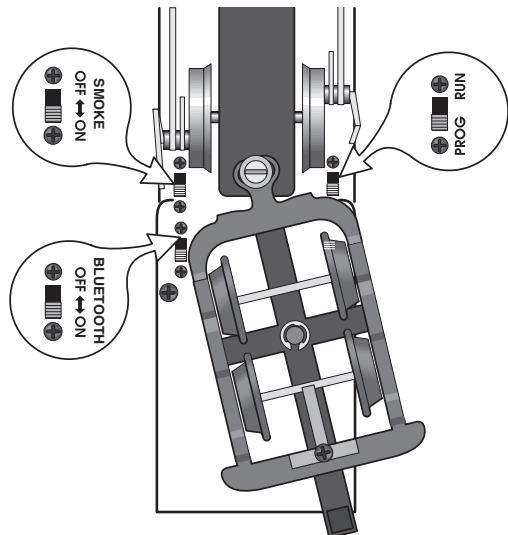

Figure 7. Switch locations

Locomotive basics

Assigning your locomotive a new ID#

For operation in the Command Control environment, you will want to give your LionChief Plus 2.0 locomotive a unique ID#. Your locomotive will respond to commands associated with its ID# while all other units will disregard these commands. ***This procedure is not necessary for conventional (non-Command) or BlueTooth operation.***

- 1. Slide the program run switch on your locomotive to the PROG position. See Figure 7 on page 8.**
- 2. Place the locomotive on the track.**
- 3. Connect the Command Base and plug it in.**
- 4. Power up the track.**
- 5. Press ENG on the CAB-1 or CAB-2 remote.**
- 6. Enter the unique ID#. Choose any number from 1 to 98 that has not been assigned to another locomotive (ENG). We recommend using a part of your locomotive's road number.**

Note! All Command Control enabled locomotives respond to ENG 99. We recommend that you reserve ID# 99 as a "universal" ID#.

- 7. Press SET. The locomotive's whistle will sound, or the headlights will flash if the RailSounds sound system is off.**
- 8. Slide the program run switch back to the RUN position.**

The LionChief Plus 2.0 locomotive ID# has been set. Be sure to record the new ID# for your reference.

LEGACY controller operations

The LEGACY CAB-2 Remote Controller

Main Display

Displays real-time information about your railroad system. Displays real-time feedback of operation.

Scroll Button

Navigates through the entire list of Engines, Trains, Switches, etc

Select Button

Performs addressing by 3-4 digit road number.

Touch Screen Key Pad

A group of touch sensitive keys with icons for each function. These keys serve many purposes and their icons change accordingly.

Train Brake Slider

This slider is used to increase or decrease the amount of Train Brake affecting the engine or train.

Train Link Button

Quick select of Train-Link devices (LEGACY Control System Version 1.3)

AUX-1/Thru Button

Press to view the Control Panel while operating. Controls switch direction.

Emergency Halt Button

Stops everything on layout; also stops recording playback.

AUX-2/Out Button

Controls switch direction. Toggles all lights on/off, except lights that are wired to track power.

Record Button

Used to record and play back events.

Velocity Throttle

Throttle control over engines, also used to navigate thru info/options.

Set Button

Used to set Engine address and for programming.

Info Button

Used to enter/view the info/options of selected components.

CTC Button

Press and hold to turn your remote on and off. Tap this button to enter the remote and base options. Tap it again to return to the main screen.

Soft Keys

These keys directly correlate to the 5 selection boxes located at the bottom of the main display. These are also used in the info/option menus to select options.

Warning Sound Controller

Warning Bell and Variable Whistle control. Pull down to sound Whistle. Push up and release to trigger Warning Bell.

Multi Controller

Boost, Brake, and Direction control. Rock forward for Boost, rock backward for engine brake, and press down for direction change. Click-hold-and rock for absolute direction selection.

Front & Rear Coupler Buttons

Fire couplers.

Feedback Button

Toggle ON/OFF the vibration feedback feature in the CAB-2 Remote.

Official R.R. Speed Control Bar

Toggles the touchscreen display of R.R. preset speeds and control panel.

Low, Medium, High Momentum Buttons

Used to select the desired momentum of your addressed engine/train/accessory.

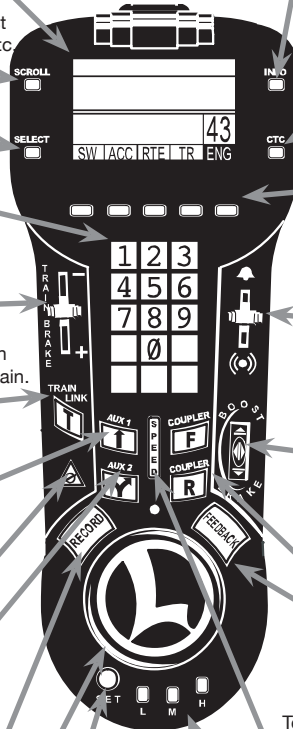

LEGACY controller operations

Note! This section is a brief overview of the LEGACY Control System. For a more in-depth explanation of the LEGACY Control System features, please see your LEGACY Control System Operations Manual, available online at www.lionel.com.

The Velocity Throttle

The Velocity Throttle (the red rotary knob on the bottom of your Lionel remote) is used to start your engine moving, slow it down or speed it up. Use it simply by turning it clockwise (speed up) or counter-clockwise (slow down).



The Multi-Controller

Direction

The direction of your engine toggles between forward and reverse at the touch of the Multi-Controller. Press the center of the Multi-Controller once, and your engine's lights will change directions and the engine will stop until you throttle up again in the new direction.

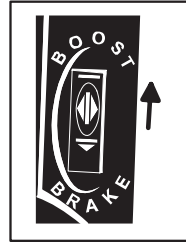

Boost & Brake

Boost and brake give you another way to control the speed of your train. Boost gives your loco a temporary increase in tractive power, and returns to the previous speed when you release the control, while the brake command slows you down more quickly than the Velocity Throttle alone.

The Train Brake Slider

The Train Brake is used to slow down and limit the top speed of your train by adding a load. The more the Train Brake is applied by pulling the Train Brake Slider down, the more laboring is heard from the engine. Eventually the Train Brake application will slow down the train and it is even possible to stop a train by pulling the Train Brake Slider all the way down.

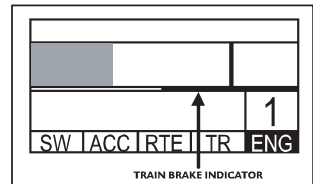
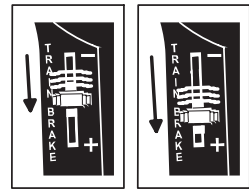

LEGACY controller operations

Warning Sound Controller

Warning sounds are an important part of Lionel Railroading. Your LionChief Plus 2.0 locomotive features a whistle/horn with 5 different selectable pitch levels. Blow the whistle by pulling down on the Warning Sound Controller.

Your LionChief Plus 2.0 locomotive features a bell with 5 different selectable pitch levels. Press the Warning Sounds Controller up to turn the continuous bell on. Press up again to turn it off.

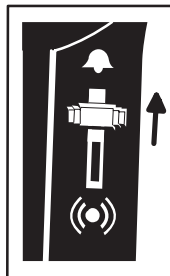

Note! Your LionChief Plus 2.0 locomotive features customizable whistle and bell sounds available through your CAB-2 or CAB-1 remote control systems. Simply press the AUX 1 button followed by the whistle or bell and your locomotive will cycle through the available bell and whistle sounds. This feature is similar to the pitch slider options found in the LionChief Bluetooth app.

The Speed Bar

The Speed Bar is used to select a new touch-screen Icon Control set. This set of touch-screen keys is used to select prototypical preset speeds. The speed of the engine changes with each press and release of a different Preset Speed key.

- Tap a key, and your locomotive will immediately begin moving to that speed.

You can also use the Velocity Throttle and other action controls in this mode and continue to use Preset speeds at the same time.

Press **AUX1** to leave the Preset speed mode and return to the Standard Control Panel. Press the speed bar to toggle between the Speed Control Panel and the Standard Control Panel.

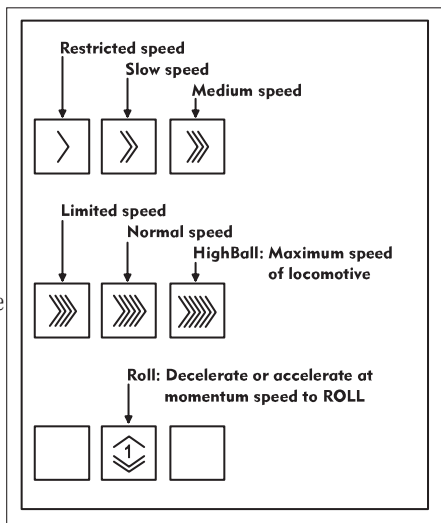

RailSounds Sound System operations

RailSounds sound system

Volume UP

Raises the overall master volume of the RailSounds sound system. To independently adjust the level of the background sounds only (e.g., the chuffing sounds and steam hiss), tap AUX1 and then this key.

CrewTalk

Engineer begins radio dialog, dispatcher replies.

Water Tower

Plays the sounds of the water tower refilling the tender

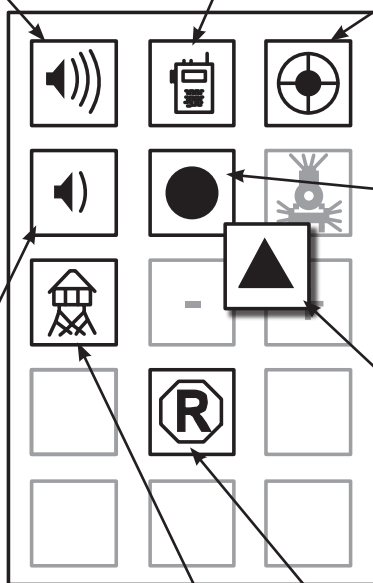

RailSounds Shutdown

Activates the RailSounds sound system shutdown sequence when stopped.

Emergency Stop

Activates the emergency stop feature while in motion. (Icon will change as the state of the locomotive changes).

Volume DOWN

Lowers the overall master volume of the RailSounds sound system. To independently adjust the level of the background sounds only (e.g., chuffing sounds and steam hiss), tap AUX1 and then this key. Volume settings are retaining when track power is turned off.

Stops and resets the locomotive

Resets the locomotives direction to forward. Press and hold to activate a fueling sequence. Fueling sounds.

TrainSounds Dialog

Activates dialog of crew working around and on the train.

When adjusting the overall volume, you'll hear a single bell hit that gets louder or softer with each volume adjustment. When the volume is at maximum, additional button presses have no effect and won't play the bell. When adjusting the background sounds (AUX1, then a volume key) you'll hear the volume change without a single bell hit.

Using the Bluetooth LionChief App

Note! Available for both Apple and Android small hand-held smart devices.



Connecting to your LionChief, LionChief Plus, LionChief Plus 2.0, FlyerChief, or Legacy locomotive on Apple devices

Once you have downloaded the free LionChief app and your locomotive is powered up on the track, tap the LionChief icon on your Apple or Android smart device.

This screen will be present and within a few seconds it will automatically connect with your locomotive. Once it has connected, your Bluetooth enabled locomotive will show up in the locomotive box. You are now ready to operate your locomotive.

Note! Your Bluetooth engine will blow the horn/whistle once when it has connected to a Bluetooth device.



Figure 8a. App screen when trying to connect to a locomotive

Figure 8b. App screen when a locomotive is connected



What if my Bluetooth enabled engine didn't automatically connect?

Tap on the locomotive box. Your locomotive will show up at top, click the link button and you're all set to begin running your locomotive.



Figure 9. App screen to select a locomotive

Using the Bluetooth LionChief App

Connecting to your LionChief, LionChief Plus, LionChief Plus 2.0, FlyerChief, or Legacy locomotive on Android devices

To locate your Bluetooth enabled locomotives on Android devices, tap on the number. This will take you to the engine selection menu. Tap the looking glass icon and the app will begin searching for compatible locomotives. Once the locomotive you want to run shows up on the selection bar, select it and then tap the link icon.

Note! Your Bluetooth engine will blow the horn/whistle once when it has connected to a Bluetooth device.



Figure 10a. App screen when opening the app

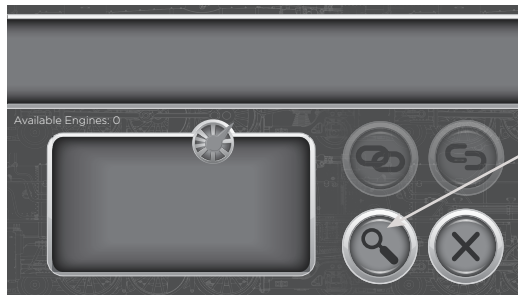

Figure 10b. App screen when searching for a locomotive



Figure 10c. App screen when a locomotive is connected

Using the Bluetooth LionChief App

Running your locomotive

This is your main control panel.

Note! Grayed out icons means this feature is not available on your locomotive.

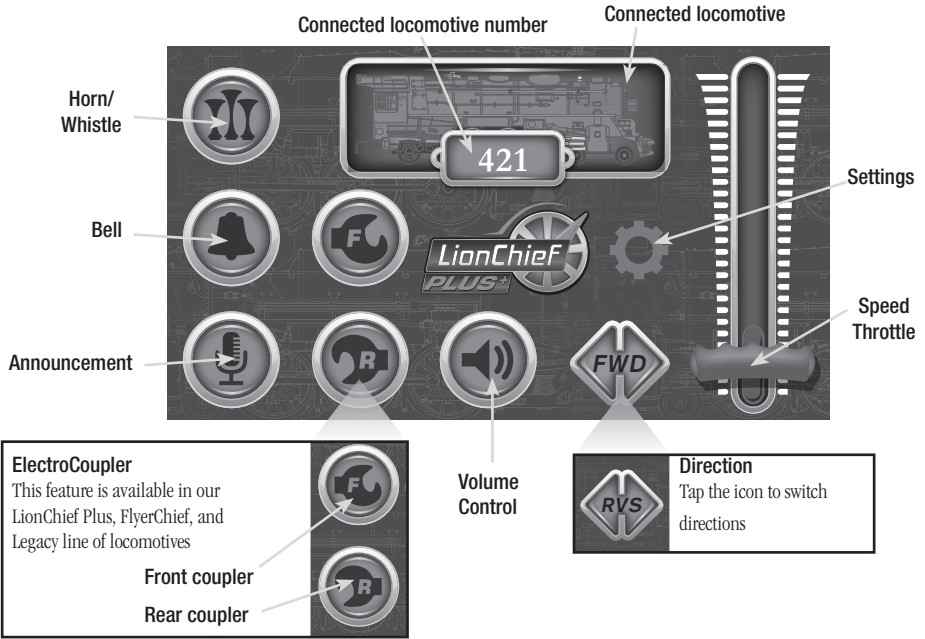
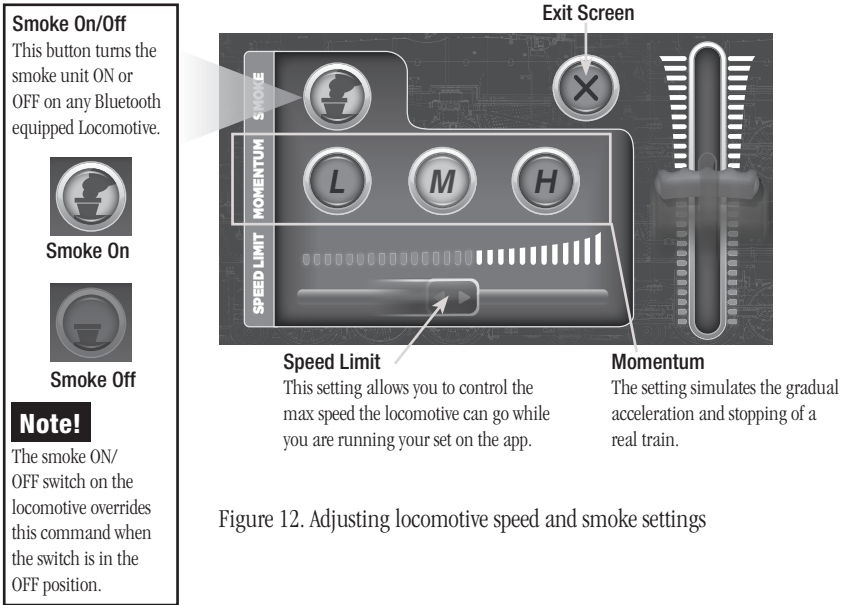

Figure 11. Controlling your locomotive with the app

Using the Bluetooth LionChief App

Settings

On the setting screen, you will be able to establish key elements of how your locomotive will run including smoke, momentum and speed limit. These settings will reset once you are done running the locomotive and close out of your LionChief app.



Smoke On/Off
This button turns the smoke unit ON or OFF on any Bluetooth equipped Locomotive.

Smoke On
Smoke Off

Note!
The smoke ON/OFF switch on the locomotive overrides this command when the switch is in the OFF position.

Exit Screen

SPEED LIMIT
This setting allows you to control the max speed the locomotive can go while you are running your set on the app.

Momentum
The setting simulates the gradual acceleration and stopping of a real train.

Speed Limit
This setting allows you to control the max speed the locomotive can go while you are running your set on the app.

Momentum
The setting simulates the gradual acceleration and stopping of a real train.

Figure 12. Adjusting locomotive speed and smoke settings

Volume Control

Our LionChief, LionChief Plus, LionChief Plus 2.0, FlyerChief, and Legacy locomotives come equipped with a very impressive RailSounds sound system. This section of the app will allow you to establish the volume for individual sound elements or the overall sound level.

Note! Once these are established here, the characteristics will continue both on the app or with your remote until you choose to change them again.

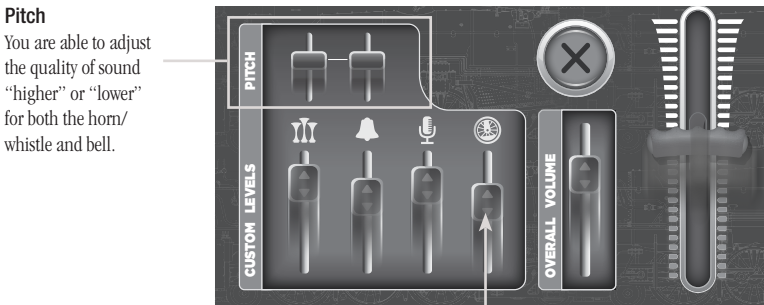

Pitch
You are able to adjust the quality of sound “higher” or “lower” for both the horn/whistle and bell.

CUSTOM LEVELS

OVERALL VOLUME

Train Sounds
Diesel revving or steam chuffing

Figure 13. Adjusting locomotive individual and overall volume levels

Using the Bluetooth LionChief App

Switching Connection Between Multiple Bluetooth® Locomotives

Your LionChief app will display all “available” locomotives in the engine selection carousel. If you have three or more available engines, touch and scroll right to view them. Switching between available locomotives is easy, press the un-link icon to release the currently connected engine. Alternately, you can highlight the engine you would like to run and press the Link icon to connect. In both cases, if the previously selected locomotive was in motion, it will stop when disconnected.

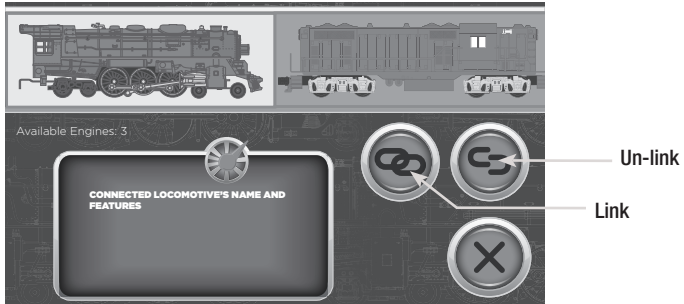

Figure 14. Switching between three locomotives

Troubleshooting

- If the locomotive does not appear in the App's “engine selection carousel,” try turning the track power off, wait 5 seconds and turn it back on. If that still doesn't work, try restarting the app on your device.
- If a universal remote is present and powered on, make sure one of its 3 channels is not connecting to your locomotive before the app is able to connect.
- Make sure that your smart device's Bluetooth is turned on. This is done outside of the LionChief app.
- Make sure that the Bluetooth switch on your locomotive is set to the 'on' position.

Note! Your LionChief Plus 2.0 locomotive can receive commands from both a Bluetooth and a TMCC controller at the same time. You may disable Bluetooth control if desired by moving the Bluetooth ON/OFF switch to the OFF position. Refer to Figure 7 on page 8.

Using the LionChief Universal Remote

The LionChief Universal Remote (6-83071)

Note!

Please refer to your LionChief Universal Remote manual for in-depth details of operation.

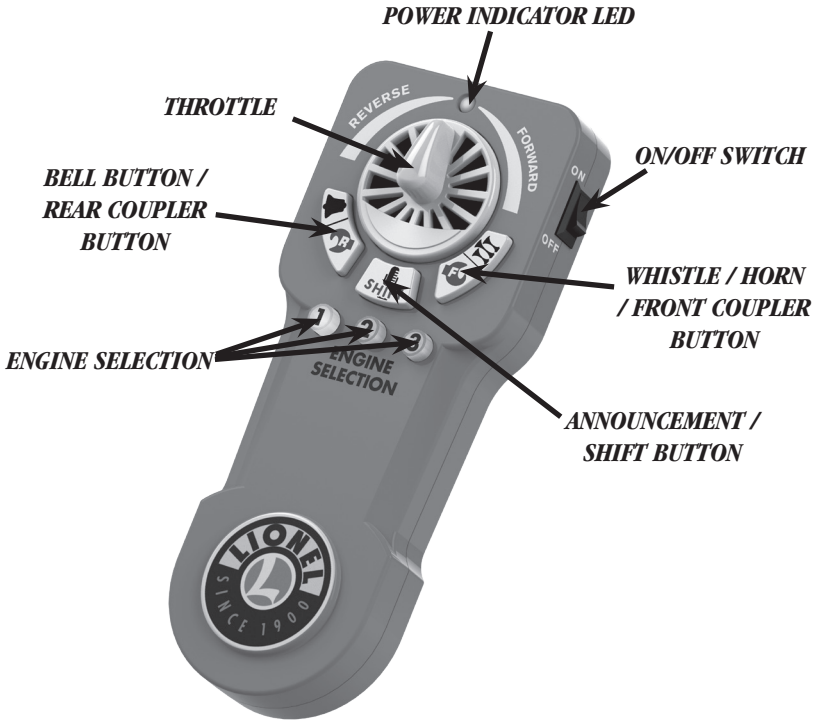

POWER INDICATOR LED

When solidly illuminated, this red LED indicates the remote is turned on. When the remote pairs with a locomotive it will visually reflect the speed on the locomotive; solidly illuminated for idle, slow to fast blink, based on the speed of the locomotive. If the LED does not illuminate when the remote is switched on, the batteries need to be replaced.

ANNOUNCEMENT / SHIFT BUTTON

Press and release the announcement button to activate the locomotive's announcements. Press and hold the Announcement button for it to function as a "shift key".

ON/OFF SWITCH

Use this switch to turn the Universal Remote on and off. We recommend you turn the remote off when not in use to conserve battery life.

Using the LionChief Universal Remote

The LionChief Universal Remote continued

WHISTLE / HORN / FRONT COUPLER BUTTON

Press the Whistle / Horn button to activate the horn / whistle. To activate the front coil coupler on the locomotive press and hold the Announcement button down and, using another finger, press and release the Whistle/Horn button to activate the front coupler. Then release the Announcement/Shift button.

BELL BUTTON / REAR COUPLER BUTTON

To turn the bell on, press the bell button one time. To turn the bell off press the button again. To activate the rear coil coupler on the locomotive press and hold the Announcement button and, using another finger, press and release the Bell button to activate the rear coupler. Then release the Announcement/Shift button.

ENGINE SELECTION

1, 2, 3

Each Engine Selection button represents a channel for controlling one LionChief, LionChief Plus, LionChief Plus 2.0 or Legacy Bluetooth locomotive. Each of these buttons may be “paired” with a different locomotive. Once paired, you can control multiple locomotives from one remote by pressing an Engine Selection button, then using the throttle, horn, bell, etc.

Note! Your remote will remember all locomotive pairings when you turn everything back on for your next operating session.

THROTTLE

Turn the throttle clockwise slowly to increase speed in the forward direction. Returning the throttle to the top dead center position will bring the locomotive to a stop. Moving the throttle counterclockwise will increase the speed of the locomotive in reverse. The Throttle also functions as the volume control. Refer to “Adjusting the locomotive volume” section in this manual for more detailed information.

Using the LionChief Universal Remote

Adjusting the locomotive volume with the Universal Remote

To adjust the overall volume of the locomotive's sound system begin by placing the throttle in the top dead center position (so the red LED is solidly illuminated and the locomotive is stopped). Press and hold the Announcement button then turn the throttle to the left and / or right, this will increase and decrease the overall locomotive volume. Continue holding the Announcement button when turning the throttle, you can stay in this mode until the volume is at the level you desire. Once the volume level is set to the level you want release the Announcement button and return the locomotive throttle to the top dead center position again. (The new volume level will remain until you change it in the future, even after power has been cycled.) If, after running the locomotive, you decide to change the volume, simply follow the steps above to do so.

Note!

If the throttle is not in the top dead center position before or after the volume adjustment process undesired operation will occur. Always start and finish the volume adjustment process with the throttle in the top dead center position!

Pairing locomotives to the Universal Remote

Your Universal Remote can connect or “pair” to one, two or three different locomotives at a time. Each “target” locomotive will be associated with one Engine Selection Button. Once you've paired with a locomotive, you can run it.

However, only “available” locomotives can be paired with the Universal Remote. “Available” means “not currently controlled by any other remote.” An available locomotive will be powered up.

To Pair a Locomotive to Engine Selection button #1

1. Turn on power to your Universal Remote
2. Press and hold Engine Selection button #1 until it blinks rapidly. This will clear any previously stored pairing information so you can connect to the new target locomotive.
3. Release the button. It should flash slowly, indicating it is not connected to a locomotive.
4. Place the target locomotive on the track and apply track power.
5. Tap and release Engine Selection button #1. The remote will now seek and connect to the first available locomotive it finds.
6. Engine Selection button #1 should now be on (no flashing), the engine will play a short whistle blast to indicate it is connected.
7. Run the locomotive!

This locomotive pairing is now stored in your Universal Remote. The next time this engine and remote are powered on, the connection will be automatically re-established.

To Pair a Locomotive to Engine Selection buttons 2 or 3, simply follow the same steps with the other two Engine Selection Buttons.

Note!

Bluetooth locomotives cannot be operated by the Universal Remote if they are already under the control of the LionChief App or another Universal Remote.

Using the LionChief Universal Remote

Operating locomotives with the Universal Remote

Now that you have paired locomotives with the Universal Remote its time to run trains! Operation with the Universal Remote is very similar to using the basic remote included with your locomotive. Switch between the locomotives you want to control by pressing different Engine Selection buttons.

Using the Throttle with multiple locomotives

Familiarize yourself with the Universal Remote by putting just one locomotive in motion at a time. Once you are comfortable as to which button is paired to what locomotive, try putting multiple locomotives in motion using the Universal Remote.

As soon as you press a different Engine Selection button, you can command the newly selected engine to blow its whistle, ring the bell or trigger dialog. However, throttle control does not automatically switch!

To take throttle-control of the selected engine, you have two choices: You can make the locomotive match the remote's current throttle position—or—you can change your remote's throttle position to match the engine's current speed and direction.

To immediately force the engine to match the throttle, just press that Engine Selection button a second time. The locomotive will immediately honor the current position of your throttle. This may result in an abrupt change in speed and/or direction.

Option two will avoid the possibility of an abrupt speed change. After pressing the Engine Selection button once, manually turn your throttle knob until it matches the locomotive's current speed and direction. Once you've matched the knob position, the main red LED will begin flashing at a rate proportional to the engine's speed. From this point on, further throttle rotation will change the engine's speed and/or direction.

Here's an example showing the “throttle matching” option in action.

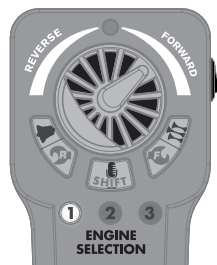

Engine #1 (above) is a diesel with throttle set for forward direction, medium speed.

Using the LionChief Universal Remote

Operating locomotives with the Universal Remote continued

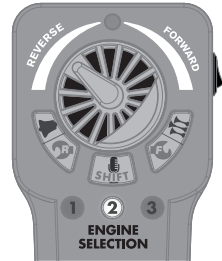

Engine 2 (above) is a steamer at stop. Press Engine Selection button #2 and turn the throttle counter-clockwise through the 12 o'clock (stop) position and continue to put this loco in reverse at slow speed. Meanwhile, notice that engine #1 is still moving forward as before.

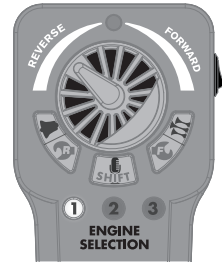

Now, switch back to engine #1, the diesel. Note that even though the throttle is in the reverse/slow speed position, the diesel continues moving forward at medium speed.

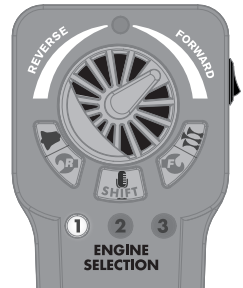
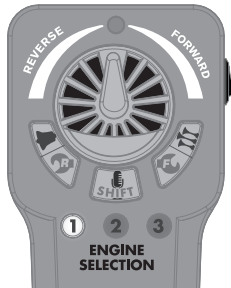
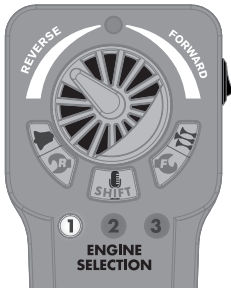

Match!

To regain speed and direction control over diesel locomotive #1, you must match the throttle position to the engine's current speed and direction. Turn the throttle clockwise. Once you've matched the throttle position, additional throttle adjustments will again cause speed and direction changes of the currently selected engine.

TrainMaster Command Control operations

CAB-1 Remote Controller commands

The CAB-1 Remote Controller commands are detailed below. The corresponding RailSounds sound system effects are in bold italic type.



Releases the ElectroCoupler on the rear of the tender. *Coupler release sound.*



Activates the numeric keypad. *Short steam release sound.*



Controls switch direction. Toggles all lights on/off, except lights that are wired to track power.



Accelerates the locomotive with a clockwise rotation. Decelerates the locomotive with a counter-clockwise rotation. *Speed-dependent chuffing sounds. DynaChuff dynamic chuffing effect.*



Activates the locomotive's whistle. Release the button to discontinue the sound. *Whistle sound with steam effect.*



Toggles the bell sound on and off. *Bell sound.*



Changes the locomotive's direction. The locomotive decelerates to a stop and continues in the opposite direction when you increase the throttle. *Air release sound.*



Increases the locomotive's speed while the button is pressed. Release the button to return to the initial speed. *Labored chuff.*



Decreases the locomotive's speed while the button is pressed. *Squealing brake sounds.*



Shuts down all PowerMasters on your railroad. Stops all TrainMaster Command Control-equipped locomotives in operation. Use HALT only in emergency situations.



Odyssey II Momentum

- L** 32 speed steps with low momentum
- M** 100 speed steps with low momentum
- H** 100 speed steps with medium momentum

TrainMaster Command Control operations

CAB-1 Remote Controller numeric keypad commands

When you press the AUX1 button on your CAB-1 Remote Controller, you turn the numeric keypad into ten command buttons. After you press the **AUX1** button, you will be able to press any numbered button until you address a different product. *The corresponding RailSounds sound system effects are in italic type.*



Stops and resets the locomotive. Resets the locomotive's direction to forward.

Your locomotive keeps track of its coal and water levels. Higher engine speeds and/or heavy labor will use fuel at a faster rate. Like a prototypical steam locomotive, water is consumed at a faster rate than coal.

To add both coal and water, perform a "long reset." Press and hold **AUX1 and 0** for at least three seconds. You will hear the sounds of coal pouring into the tender as long as you hold the button. When you release the button, the sounds will stop and the engineer will confirm that the tank is full. *Refueling sequence.*



Raises the overall master volume of the LEGACY RailSounds sound system. To independently adjust the level of the background sounds only (e.g., the chuffing and steam hiss), tap **AUX1** and then this key. *Sound volume increases.*

When adjusting the overall volume, you'll hear a single bell hit that gets louder or softer with each volume adjustment. When the volume is at maximum, additional button presses have no effect and won't play the bell. When adjusting the background sounds (**AUX1**, then a volume key) you'll hear the volume change without a single bell hit.



Engineer begins radio dialog, dispatcher replies.



At a stop, plays the sound of a water tower spigot arm lowering, then water gushing from the tower into the tender, which also "refills" the virtual water level in the tender. *Water injector/water tower sounds.*

TrainMaster Command Control operations

CAB-1 Remote Controller numeric keypad commands (continued)



Lowers the overall master volume of the LEGACY RailSounds sound system. To independently adjust the level of the background sounds only (e.g., chuffing and steam hiss), tap **AUX1** and then this key. Volume settings are retaining when track power is turned off. *Sound volume decreases.*



Activates the LEGACY RailSounds sound system shutdown sequence when stopped. Activates the emergency stop feature while in motion. Note that, in the shutdown sequence, the smoke unit will turn off if it was already on.



Triggers the *Blowdown sound*.



Activates TrainSounds.



Turns off the smoke unit if the unit is in Low smoke production mode. *Let-off sound.*



Turns on the smoke unit if the smoke unit's switch is in the ON position. Be sure to add smoke fluid before turning on the smoke unit to prevent damage to your locomotive. *Let-off sound.*

Note! **AUX1, 8** and **9** function only if the locomotive's smoke unit switch is in the ON position.

Setting the smoke level

You may adjust the level of smoke production using your remote. The 9 key increases smoke production while the 8 key decreases smoke production. See the sequences below.

Smoke production		Cab key	
No	→	Low	9
Low	→	Medium	9
Medium	→	High	9
High	→	Medium	8
Medium	→	Low	8
Low	→	No	8

Customizable Whistle and Bell Feature

Your LionChief Plus 2.0 locomotive features customizable whistle and bell sounds available through your CAB-2 or CAB-1 remote control systems. Simply press the AUX 1 button followed by the whistle or bell and your locomotive will cycle through the available bell and whistle sounds. This feature is similar to the pitch slider options found in the LionChief Bluetooth app.

Conventional transformer operations

Using the RailSounds sound system in the conventional environment

When you first power up your LionChief Plus 2.0 locomotive you will hear the sounds of the locomotive at rest. As the locomotive moves, the chuff sounds automatically increase with the locomotive's speed. In the conventional environment, the whistle and bell sounds are activated by your transformer controls, if so equipped.

In the conventional environment, you will experience several features of the RailSounds sound system.

- **DynaChuff.** Your locomotive's speed automatically determines the character of the chuffing sounds. At low speeds, the chuffing sounds are longer. When you highball down the mainline, the chuffing intensity becomes more percussive.
- **Bell.** Press BELL on your transformer to begin the effect, then press BELL a second time to discontinue the effect.
- **CrewTalk dialog.** These brief conversations between the train crew and the tower are triggered by short whistle blasts.

Activating the CrewTalk dialog

In the conventional environment, CrewTalk dialog is triggered by short whistle blasts and vary with the state of the LionChief Plus 2.0 locomotive.

- If the locomotive has been stopped for less than 15 seconds, a short whistle blast triggers a "please standby" dialog.
- If the locomotive has been stopped for longer than 15 seconds, a short whistle blast triggers a "cleared outbound" dialog.
- If the locomotive has started moving within the last seven seconds, a short whistle blast will trigger a "train is underway" dialog.
- If the locomotive has been moving for more than seven seconds, a short whistle blast will trigger a "are we clear?" dialog.

Conventional transformer operations

Locking your locomotive into a single direction

When the Command reverse unit switch is in the RUN position, your locomotive sequences through a repeating pattern of operations: forward, neutral, reverse, neutral, and so on.

To “lock” your locomotive into a single direction (for example, to operate in forward only), you can deactivate the Command reverse unit’s sequencing function.

- 1. Use your transformer’s DIRECTION button or interruptions in track power to get your locomotive moving slowly in the desired direction or into neutral.**
- 2. Slide the Command reverse unit switch to the PROG position. At this point, the locomotive is “locked” into your chosen direction. See Figure 7 on page 8 for the location of this switch.**

To restore the forward-neutral-reverse sequence, just slide the Command reverse unit switch back to the RUN position.

Note! Because of the way that speed control operates in conventional mode, you will notice a slight delay between adjusting your transformer throttle and the change in the speed of your locomotive.

Reprogramming your locomotive to restore features

If your LionChief Plus 2.0 locomotive is unresponsive to your commands in the Command Control environment, we recommend that you follow this procedure to reset your locomotive. All factory default settings will be restored when you reprogram the locomotive.

- 1. Slide the program run switch to the PROG position.**
- 2. Plug in and connect your LEGACY Base.**
- 3. Place your locomotive on the track, then power up the track.**
- 4. Press ENG and enter the locomotive’s ID#.**
- 5. Press SET.**
- 6. Turn off track power and wait ten seconds.**
- 7. Slide the program run switch back to the RUN position.**

At this point, your LionChief Plus 2.0 locomotive has been reset. Restore power to the track and operate the locomotive as usual. Be sure to use the ID# entered in Step 4.

Maintaining and servicing your locomotive

Lubricating your locomotive

Help your LionChief Plus 2.0 locomotive lead a long and productive life on your railroad by maintaining it properly. To keep your locomotive lubricated, we recommend that you purchase a Lionel Lubrication and Maintenance Kit (6-62927), available from your authorized Lionel dealer.

When you find that the lubrication points illustrated in Figures 15 and 16 appear dry, lubricate your locomotive after you have removed any accumulated dirt and dust. There are two basic rules to keep in mind when you are lubricating your locomotive: use only a small amount of lubrication and avoid getting grease or oil on your locomotive's wheels, roller pickups, or the track.

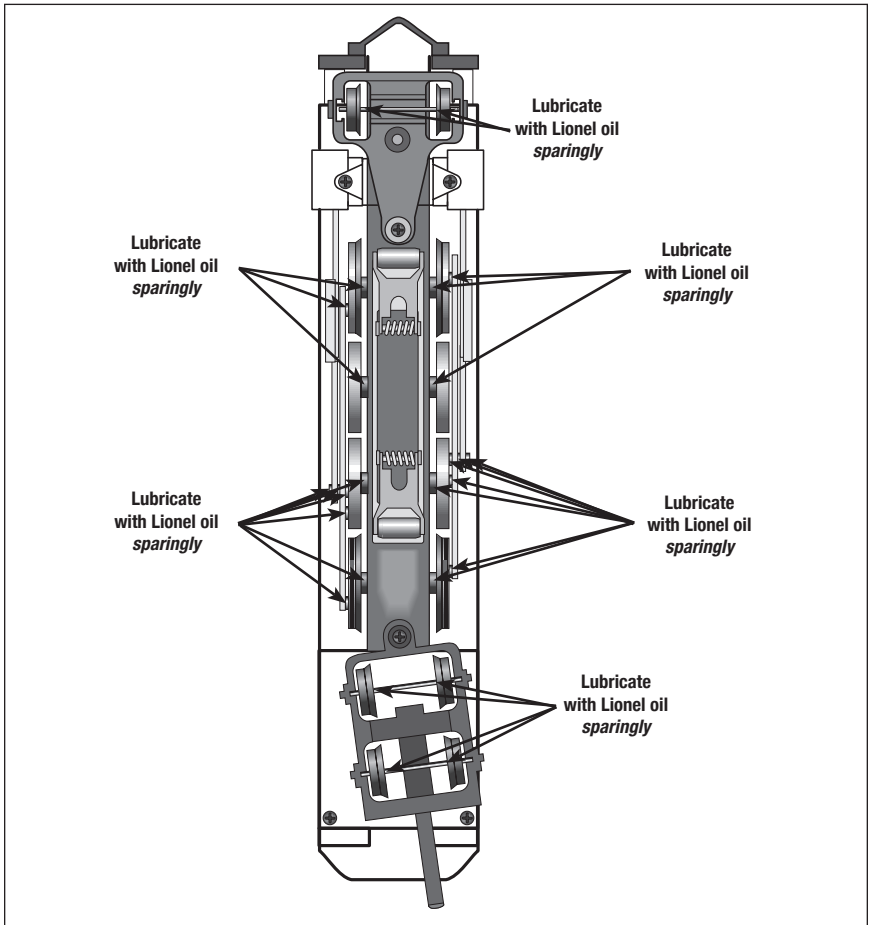

Figure 15. Locomotive lubrication points

Maintaining and servicing your locomotive

Lubricating your locomotive continued

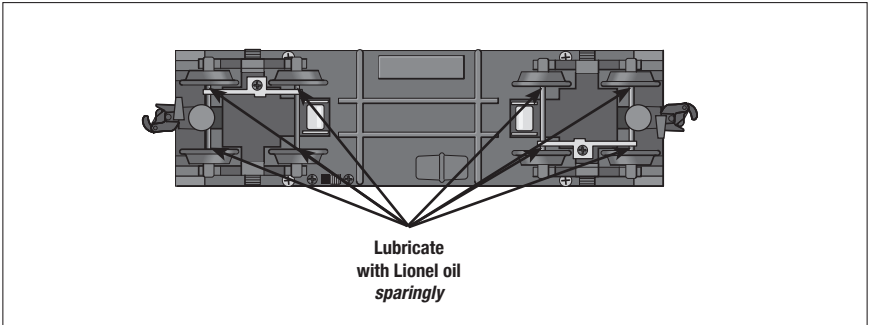

Figure 16. Tender lubrication points

Servicing your locomotive's LEDs

Note! If the locomotive is powered up and the lights are not on, check that the **AUX2** command was not used to turn the lamps off.

Your LionChief Plus 2.0 locomotive is illuminated by several LEDs that are expected to last for the life of the locomotive. The LED's are not user serviceable. If service is required, we recommend that you have your locomotive serviced at a Lionel Factory Trained Authorized Service Station or Lionel Service.

Maintaining and servicing your locomotive

Maintaining your locomotive's handrail antennas

The handrails on your LionChief Plus 2.0 locomotive are the antennas that receive the Radio Signal communication from the Command Base. For optimum reception, the handrails have been insulated from the die-cast body. Please handle the locomotive carefully to avoid handrail damage. The handrails should not touch the locomotive body.

If your locomotive appears to have problems receiving communications from the Command Base, be sure that the ends of the handrails are insulated from the body with either an insulating washer or plastic handrail stanchion.

Replacing the traction tires

Your LionChief Plus 2.0 locomotive is equipped with traction tires. This means that some of the drive wheels are fitted with rubber traction tires to enhance tractive effort so your locomotive can pull many cars at once.

Lionel has provided extra traction tires to replace the installed traction tires if they ever wear out. The traction tires are replaced by unscrewing the drive rod screws using the supplied wrench or with a Phillip's head screwdriver. See Figure 17. Slip off the old traction tire and remove it from under the drive rod. Place the new traction tire on the wheel and re-tighten the drive rod screw.

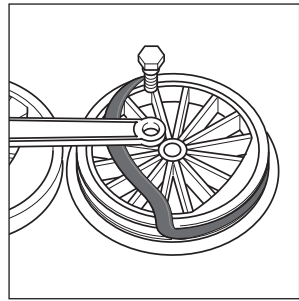

Figure 17. Replacing traction tires

Locomotive Diagnostics

Your LionChief Plus 2.0 locomotive includes built-in diagnostics to monitor the condition of the main drive motor. If a problem is detected, the locomotive's cab light will blink a diagnostic code.

If you see the light inside the cab flashing, press **RESET** (for LEGACY operation), **O** (for TMCC operation), or **DIRECTION**/power interruption (for conventional operation) to attempt to clear the problem. The locomotive will immediately check itself again. If the problem persists, it must be returned to a local Factory Trained Authorized Lionel Service Station, or contact Lionel Customer Service for repair.

Number of Blinks	Diagnostic Code Description
------------------	-----------------------------

1	Main drive motor stalled.
---	---------------------------

Lionel Limited Warranty Policy & Service

This Lionel product, including all mechanical and electrical components, moving parts, motors and structural components, with the exception of **LIGHT BULBS, LED's & TRACTION TIRES** are warranted to the original owner-purchaser for a period of **one year from the original date of purchase** against original defects in materials or workmanship when purchased through a **Lionel Authorized Retailer***.

This warranty does **NOT** cover the following:

- Normal wear and tear
- Light bulbs or LED's
- Defects appearing in the course of commercial use
- Damage resulting from abuse/misuse of the product

Transfer of this product by the original owner-purchaser to another person voids this warranty in its entirety. Modification of this product in any way; visually, mechanically or electronically, voids the warranty in its entirety.

Any warranted product which is defective in original materials or workmanship and is delivered by the **original owner-purchaser** (this warranty is non-transferable) to Lionel LLC or any Lionel Authorized Service Station **MUST** be accompanied by the original receipt for purchase (or copy) from an **Authorized Lionel Retailer***, will at the discretion of Lionel LLC, be repaired or replaced, without charge for parts or labor. In the event the defective product cannot be repaired, and a suitable replacement is not available, Lionel will offer to replace the product with a comparable model (**determined by Lionel LLC**), if available. In the event a comparable model is not available the customer will be refunded the original purchase price (requires proof of purchase from the **Authorized Lionel Retailer*** it was originally purchased). Any products on which warranty service is sought must be sent freight or postage prepaid (Lionel will refuse any package when postage is due). **Transportation and shipping charges are not covered as part of this warranty.**

NOTE: Products that require service that do not have a receipt from an LIONEL AUTHORIZED RETAILER* will be required to pay for all parts required to repair the product (labor will not incur a charge) providing the product is not older than 3 years from date of manufacture and is within 1 year from date of purchase. A copy of the original sales receipt is required.

In no event shall Lionel LLC be held liable for incidental or consequential damages.

Some states do not allow the exclusion or limitation of incidental or consequential damages, so the above exclusion may not apply to you. This warranty gives you specific legal rights and you may have other rights which vary from state to state.

Instructions for Obtaining Service

If service for this Lionel LLC product is required; bring the item, along with your DATED sales receipt and completed warranty information (at the bottom of this page) to the nearest Lionel Authorized Service Station. Your nearest Lionel Service Station can be found by calling 1-800-4-LIONEL or by accessing the website at www.lionel.com.

If you prefer to send your Lionel product directly to Lionel, for repair you must FIRST call 1-800-4LIONEL (1-800-454-6635) or write to Lionel Customer Service, 6301 Performance Drive, Concord, NC 28027. Please have the 6-digit Lionel product number, the date of original purchase, the dealer where the item was purchased and what seems to be the problem. You will receive a return authorization (RA) number to ensure your merchandise will be properly tracked and handled upon receipt at Lionel LLC.

Once you have your Return Authorization (RA) number, make sure the item is packed in its original Styrofoam inner container which is placed inside the original outer display box (this will help prevent damage during shipping and handling). This shipment **MUST** be prepaid and we recommend that it be insured with the carrier of your choice.

Please make sure you have followed all of the above instructions carefully before returning any merchandise for service. You may choose to have your product repaired by one of Lionel LLC's Authorized Service Stations after its warranty has expired. A reasonable service fee should be expected once the product warranty has expired.

Warranty Information

Please complete the information below and keep it, along with your **DATED ORIGINAL SALES RECEIPT**. You **MUST** present this form **AND** your **DATED SALES RECEIPT** when requesting warranty service.

*A complete listing of Lionel Authorized retailers can be found by calling 1-800-4-LIONEL or by visiting our website at www.lionel.com.

Products that are more than 3 years old, from date of manufacture, are not applicable for warranty coverage, even if they have never been sold prior to this date. (Under no circumstance shall any components or labor be provided free of charge.)

Name _____

Address _____

Place of Purchase _____

Date of Purchase _____

Product Number _____



© 2019 LIONEL L.L.C.
6301 Performance Dr., CONCORD, NC 28027
UNITED STATES OF AMERICA
PRINTED IN CHINA