

20333360250
5/23



Lionel E8/E9 AA Set Owner's Manual



Thank You!

Thank you for your purchase of this Lionel LEGACY diesel locomotive set! On the outside, this locomotive set features numerous details and expert decoration in your favorite livery. Inside the body, this locomotive set is equipped with some of the most advanced sounds and controls in model railroading. This powerful locomotive set is ready for duty on your layout.

FCC Statement

This device complies with Part 15 of the FCC Rules and with Industry Canada license-exempt RSS standard(s). Operation is subject to the following two conditions: (1) This device may not cause harmful interference, and (2) This device must accept any interference received, including interference that may cause undesired operation.

Contains

P/N: BM832(A)

FCC ID: X8WBM832

IC ID: 4100A-BM832



LEGACY® Control System

This revolutionary control system allows you to run your LEGACY Control System-equipped locomotive just like a real engineer runs his trains. With its enhanced sounds and 200 speed steps, this system allows properly equipped engines to function with unparalleled options. The CAB-2 Remote Controller has an LCD screen display, vibration that simulates the effort of the locomotive, and other exciting operating features. The new CAB-IL Remote Controller is a simplified alternative to unlock many LEGACY features.



ODYSSEY II® Speed Control

Slow speed and start-up operation are smooth and steady with ODYSSEY II Speed Control. Watch your locomotive as it creeps through the yard or fights up a grade without hesitation.



LEGACY® RailSounds®

Widely regarded as the industry standard, the impressive RailSounds sound system brings the real sounds of the railroad to your layout. From the mechanical symphony of the locomotives, to the commotion of the station, you will be impressed by the digitally recorded samples of these special and authentic sounds.



LionChief® Bluetooth®

Incorporating Bluetooth technology into Lionel model trains opens a new world, integrating the tradition of model railroading with the latest smart-device technology. With Lionel's new LionChief app, you can control full operation and sounds directly from your Bluetooth-enabled smart phone or tablet and operate multiple locomotives from the same device. LionChief is available to smartphone users and is compatible with all new 2017 to current LionChief, LionChief Plus, S-Gauge, and HO Trains.



Lionel Voice Control

Simply speak a command into your phone via your LionChief app and watch as your engine follows your lead! The Lionel Voice Control feature is available on all new and previously produced Bluetooth equipped engines.

Table of Contents

Running your locomotive set

Powering your locomotive set	5
LEGACY Control operations (AC power only)	5
TrainMaster Command Control (TMCC) operations (AC power only)	6
Conventional transformer operations (AC power only)	7

Locomotive set basics

Adding smoke fluid to your locomotive set's smoke generators	8
Locomotive set switch locations	9-10
Assigning your locomotive set a new ID# (LEGACY and TMCC)	11
Lash-ups (for LEGACY operation only)	12

LEGACY Control System operations

The LEGACY CAB-2 Remote Controller	13
The Velocity Throttle	14
The Multi-Controller	14
The Train Brake Slider	14
The Warning Sound Controller	15
The Speed Bar	15
EFX Trim and EFX Bar Graph	16
Leaving the Preset Speed Screen	16

LEGACY RailSounds Sound System operations

LEGACY RailSounds sound system	17
LEGACY RailSounds Sequence Control	18
CrewTalk dialogue in the LEGACY environment	19

Using the Bluetooth LionChief App

Connecting your Bluetooth-equipped locomotive on Apple devices	20
What if my Bluetooth enabled engine didn't automatically connect?	20
Connecting your Bluetooth-equipped locomotive on Android devices	21
Running Your Locomotive	22
Settings	23
Volume Control	23
Switching Connection Between Multiple Bluetooth Locomotives	24
Lionel Voice Control	25-26
Troubleshooting	27

Using the LionChief Universal Remote

The LionChief Universal Remote (6-83071)	28-29
Adjusting the locomotive volume using the Universal Remote	30
Pairing locomotives to the Universal Remote	30
Operating locomotives with the Universal Remote	31-32

TrainMaster Command Control operations

CAB-1 Remote Controller commands	33
CAB-1 Remote Controller numeric keypad commands	34-35
Setting the smoke level	35

Conventional transformer operations

Using the LEGACY RailSounds sound system in the conventional environment	36
Locking your locomotive set into a single direction	36

Table of Contents continued

Maintaining and servicing your locomotive set

Reprogramming your locomotive set to restore features	37
Lubricating your locomotive set	38
Servicing your locomotive set's LEDs	39
Replacing the traction tires	39
Locomotive set diagnostics	39
Lionel Warranty	40

The Bluetooth® word mark and logos are registered trademarks owned by the Bluetooth SIG, Inc. and any use of such marks by Lionel is under license. Other trademarks and trade names are those of their respective owners.

Apple and the Apple logo are trademarks of Apple Inc., registered in the U.S. and other countries. Mac App Store is a service mark of Apple Inc.

Google Play and the Google Play logo are trademarks of Google Inc.

The following Lionel marks are used throughout this Owner's Manual and are protected under law. All rights reserved.

Lionel®, LionChief®, LionChief Plus®, FlyerChief®, TMCC®, LEGACY®, FasTrack®, TrainMaster®, Odyssey®, RailSounds®, CrewTalk™, TowerCom™, ElectroCoupler™, CAB-1™ Remote Controller, TMCC®, Wireless Tether™, SensorTrack™, DynaChuff™, MultiWhistle™

Running your locomotive set

Note! Your locomotive set requires Lionel or Lionel-compatible O-54 or larger track curves.

Powering your locomotive set

Your locomotive set is designed to work with either AC or DC power.

AC Power: Use an alternating-current (50-60Hz AC) transformer for Legacy, Bluetooth, or Conventional control. Powering your locomotive in excess of 19 volts AC may result in damage to sensitive electronic components.

DC Power: Use a DC transformer for Bluetooth control only. Your locomotive set is not designed to operate with Legacy or conventional control while using DC power. Powering your locomotive set in excess of 19 volts DC may result in damage to sensitive electronic components.

LEGACY Control operations (AC power only)

For the finest operating experience, your locomotive set is fully compatible with the LEGACY Control System. To operate in LEGACY mode, you need a LEGACY Command Base and LEGACY CAB-2 Remote Controller (6-14295).

Your commands are sent by the CAB-2 Remote Controller to the Command Base, which sends a digital code through the rails to your locomotive set. Your locomotive set will not respond until it recognizes its unique ID#, so you can operate multiple Command-equipped locomotives on the same track at the same time.

1. Turn off track power, and then plug in the LEGACY Base and connect it to the track.
2. Place your locomotive set on the track.
3. Increase track power voltage to full power (no more than 19 volts AC). If a circuit breaker trips when you turn on the Lionel power supply, check the wheels of your locomotive set to make sure they are all securely on the track. Check to make sure the track is free of all metals that may cause a short circuit.
4. As illustrated in Figure 1, press ENG and 1 (or your selected ENG ID#) to address the locomotive set with your LEGACY CAB-2 Remote Controller.
5. Press the Start Up button on your LEGACY CAB-2 Remote, shown in Figure 2. Then, throttle up and move 'em out! Your engine sound will start up, and the locomotive-specific touch screen buttons will populate the remote. For more information on operating your locomotive with the LEGACY system, please refer to the LEGACY section of this manual. Additional information is also found in the LEGACY System Manual, available online at www.lionel.com.

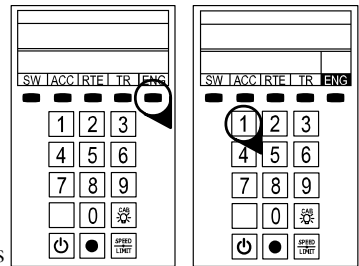

Figure 1. LEGACY engine selection

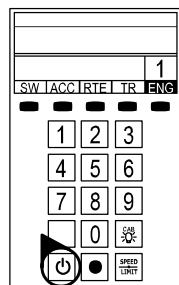

Figure 2. LEGACY start-up

Running your locomotive set

Note! Power your locomotive set with an alternating-current (50-60Hz AC) transformer only. Powering your locomotive set with a direct-current (DC) transformer, or in excess of 19 volts AC, may result in damage to sensitive electronic components.

Note! Your locomotive set requires Lionel or Lionel-compatible 0-54 or larger track curves.

Note! All Legacy locomotives are factory programmed as ENG 1.

TrainMaster Command Control (TMCC) operations (AC power only)

For operation in the TrainMaster Command Control environment, you need a TrainMaster Command Base (6-12911) and a CAB-1 Remote Controller (6-12868). Refer to your TMCC System Manual for complete information. **To access all the locomotive set's features, you must operate in the LEGACY environment, as discussed on the previous page.**

Your commands are sent by the CAB-1 Remote Controller to the Command Base, which translates the command into digital code. That code is sent through the outside rails to your locomotive set, which will not respond until it recognizes its unique ID#. TrainMaster Command Control gives you the power to operate multiple Command-equipped locomotives on the same track at the same time.

- 1. Turn off track power, and then plug in the Command Base and connect it to the track.**
- 2. Place your locomotive set on the track.**
- 3. Increase track voltage to full power (no more than 19 volts AC).** If a circuit breaker trips when you turn on the Lionel power supply, check the wheels of your locomotive set to make sure they are all securely on the track. Check to make sure the track is free of all metals that may cause a short circuit.
- 4. Press ENG and 1 (or the ENG ID# you set) to address your locomotive set with your CAB-1 Remote Controller.**
- 5. Throttle up and move 'em out.**

For more information, please refer to the TrainMaster Command Control operations section of this manual or the TMCC System Manual, available online at www.lionel.com.

Running your locomotive set

Conventional transformer operations (AC power only)

Note! For Conventional operation, a Command Base must not be powered up anywhere in the area, even if it is not connected to the track. If a base is detected, your locomotive set will default to Command mode.

Note! Power your locomotive set with an alternating-current (50-60Hz AC) transformer only. Powering your locomotive set with a direct-current (DC) transformer, or in excess of 19 volts AC, may result in damage to sensitive electronic components.

Note! Your locomotive set requires Lionel or Lionel-compatible 0-54 or larger track curves.

- 1. With track power off, place your locomotive set on the track.**
- 2. Power up the track.** If a circuit breaker trips when you turn on the Lionel power supply, check the wheels of your locomotive set to make sure they are all securely on the track. Check to make sure the track is free of all metals that may cause a short circuit.
- 3. Move 'em out!** When the lead locomotive's headlight illuminates and the LEGACY RailSounds sound system starts, press the DIRECTION button on your transformer to sequence your locomotive set through the repeating pattern of operations: neutral, forward, neutral, reverse, neutral, and so on. You may also briefly turn off track power to advance the locomotive set to the next operating state. Adjust the throttle until your locomotive set moves at your desired speed.

Note! When placing your locomotive set on your layout for the first time and after power interruptions lasting longer than five seconds, it will start out in neutral.

Use the **HORN** and **BELL** buttons on your transformer to activate those features. For more information, please refer to the Conventional transformer operations section of this manual.

Locomotive set basics

Adding smoke fluid to your locomotive set's smoke generators

Each locomotive is equipped with a smoke generator that produces safe, clean, white smoke during operation. A reservoir beneath the stack contains the fluid and a wick which, once saturated, supplies the heating element with the right amount of fluid. Add 10-20 drops to the duct (shown in Figure 3) to prime the units the first time you run the locomotive set or after being stored for an extended period of time, and then add 10 to 20 drops to refill when smoke production decreases. When refilling, **DO NOT EXCEED 20 DROPS** as this can cause your smoke units to become oversaturated allowing leakage onto the electronics. Note that operating your locomotives' smoke units without smoke fluid will cause damage to the heating element.

If you prefer to operate your locomotive set without smoke, locate the smoke unit switch on each locomotive and slide it to the NO SMK position. Refer to Figures 4a and 4b on page 10 for the location of these switches.

Note! For best performance, we recommend using only Lionel Premium Smoke Fluid.

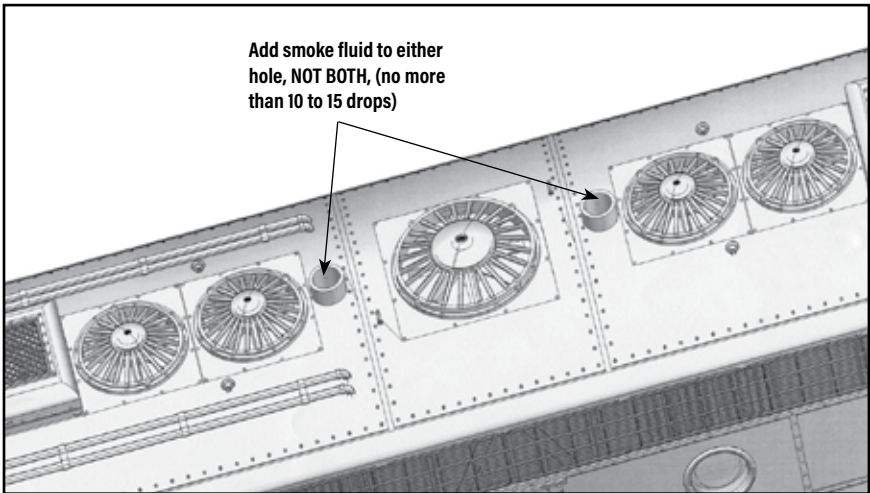

Figure 3. Smoke fluid fill location

Locomotive set basics

Locomotive set switch locations

The functions of your locomotive set's switches are outlined below. Refer to figures 4a and 4b on page 10 for the location of the switches. *The instructions below are specific to this particular locomotive set; note that available features (and switches) may differ from other locomotives and sets.*

Smoke Unit Switch (SMK/NO SMK)

Used to turn the smoke unit function on and off.

Program-Run Switch (RUN/PGM)

Used to assign an ID# and to reprogram each locomotive in this set for LEGACY and Command operation when the switch is in the PGM position. Also used to "lock" your powered locomotive in a single direction, or neutral, in conventional operation when the switch is placed in the PGM position.

Bluetooth Switch

Manually turns on/off the Bluetooth radio module in the unit.

Note! When running in Bluetooth mode with either the LionChief Universal Remote or the LionChief app, the lead A-unit must be controlled for the trailing A-unit to also be controlled. A trailing A-Unit will not run by itself via Bluetooth control.

Signals Switch

Used to enable or disable the warning signals (horn and bell).

Dialog Switch

Used to enable or disable all engineer / tower dialog and radio chatter.

Note! The trailing A-Unit with this set is powered (motorized), but does not include a sound system. RailSounds audio will only be generated by the lead A-Unit.

Locomotive set basics

Locomotive set switch locations continued

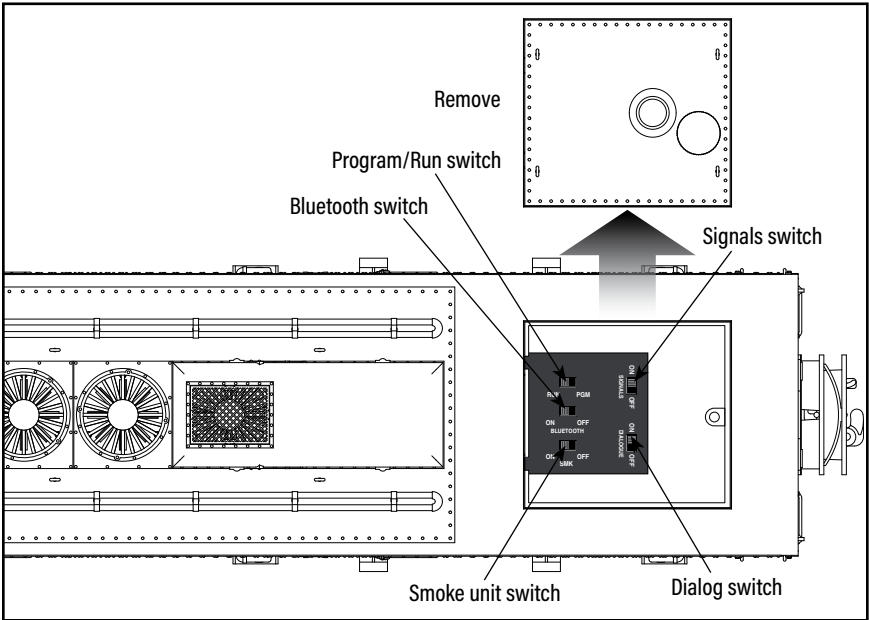

Figure 4a. Lead unit switch locations (under removable roof panel)

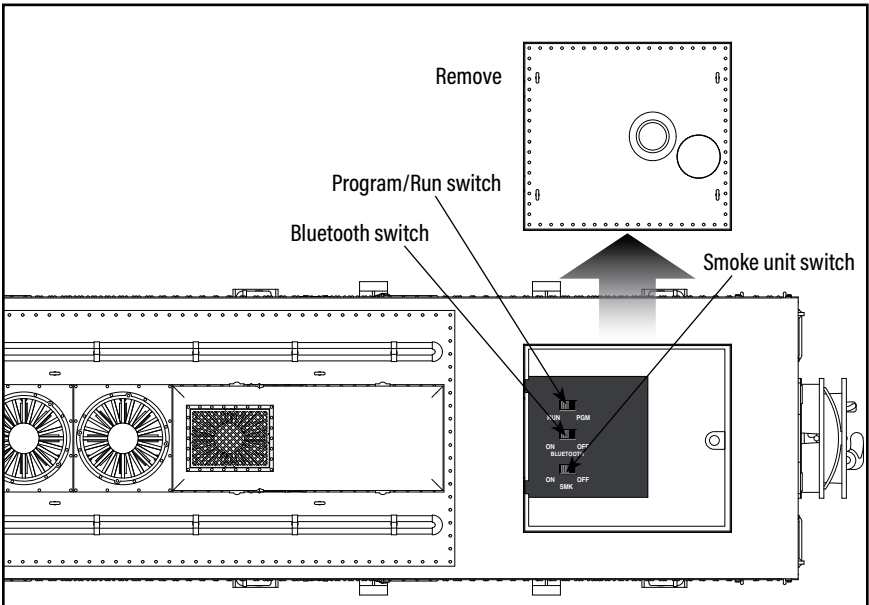

Figure 4b. Trailing unit switch locations (under removable roof panel)

Locomotive set basics

Assigning your locomotive set a new ID# (LEGACY and TMCC)

For operation in the LEGACY or TMCC environment, you will want to give each unit a unique ID#. The locomotive set will respond to commands associated with its ID# while all other units will disregard these commands. *This procedure is not necessary for conventional (non-Command) operation.*

Note! If you will be creating a lash-up (Legacy mode only - see page 12) for your Lead-A and Trailing-A engines, program each locomotive to a unique ENG ID#. Otherwise, program both units to use the same ENG ID#.

1. **Slide the Program-Run switch on your locomotive to the PGM position. See Figure 4 on page 9.**
2. **Place the locomotive on the track.**
3. **Connect the Command Base and plug it in.**
4. **Power up the track.**
5. **Press ENG on the CAB-1 or CAB-2 remote.**
6. **Enter the unique ID#. Choose any number from 1 to 98 that has not been assigned to another locomotive (ENG). We recommend using a part of your locomotive set's road number.**

Note! All LEGACY locomotives respond to ENG 99. We recommend that you reserve ID# 99 as a "universal" ID#.

7. **Press SET. On the lead A-Unit, the locomotive's horn will sound, or the headlights will flash if the RailSounds sound system is off. On the trailing A-unit, the marker lights will illuminate.**
8. **Slide the Program-Run switch back to the RUN position.**
The locomotive set's ID# has been set. Be sure to record the new ID# for your reference.

Locomotive set basics

Lash-ups (for LEGACY operations only)

In the Command environment, building a lash-up allows you to control multiple powered and non-powered locomotives as one in a prototypical manner. It is still possible to control any of the engines in the lash-up individually. When you issue a train command, the individual engine you were controlling will return to the group. If there is a difference in speed, the individual engine will return to the speed of the lash-up at the rate set in the train momentum.

To build a lash-up, assign a unique engine (ENG) ID# to each unit. See page 11 for details.

1. Address the train ID# you wish to create or edit, 1 to 98.
2. Press INFO.
3. Press BUILD softkey (button directly under BUILD).
4. Enter the front engine number. It is not necessary to enter ENG, just enter the #. It will appear in the blinking box.
5. Press ADD to add the front engine. The engine will move to the right and the blinking box will be ready for your next engine to be added.
6. Enter the second engine ID# in the blinking box.
7. Press ADD to add the second engine. The engine will move to the right and the blinking box will be ready for your next engine to be added.
8. Add all the engines you want in your lash-up in this manner.
9. To change the direction of an engine in your lash-up, turn the Velocity Throttle to move the engine you want into the blinking box. Then press DIR to change the direction of the engine.
10. To delete an engine in your lash-up, turn the red Velocity Throttle knob to move the engine you want to delete into the blinking box. Then press DEL.
11. To save your lash-up, press SET. Watch the onscreen prompts and wait until you see the message TRAIN CREATED.
12. Press CTC to exit to the operating screen.

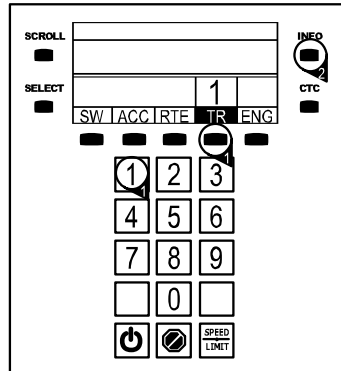

See reference numbers 1 and 2

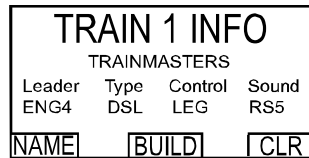

See reference number 3

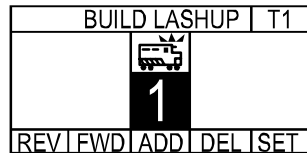

See reference number 4

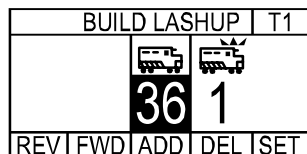

See reference numbers 6 and 7

LEGACY Control System operations

The LEGACY CAB-2 Remote Controller

Main Display

Displays real-time information about your railroad system. Displays real-time feedback of operation.

Scroll Button

Navigates through the entire list of Engines, Trains, Switches, etc.

Select Button

Performs addressing by 3-4 digit road number.

Touch Screen Key Pad

A group of touch sensitive keys with icons for each function. These keys serve many purposes and their icons change accordingly.

Train Brake Slider

This slider is used to increase or decrease the amount of Train Brake affecting the engine or train.

Train Link Button

Quick select of Train-Link devices (LEGACY Control System Version 1.3)

AUX-1/Thru Button

Press to view the Control Panel while operating. Controls switch direction.

Emergency Halt Button

Stops everything on layout; also stops recording playback.

AUX-2/Out Button

Controls switch direction. Toggles all lights on/off, except lights that are wired to track power.

Record Button

Used to record and play back events.

Velocity Throttle

Throttle control over engines, also used to navigate thru info/options.

Set Button

Used to set Engine address and for programming.

Info Button
Used to enter/view the info/options of selected components.

CTC Button

Press and hold to turn your remote on and off. Tap this button to enter the remote and base options. Tap it again to return to the main screen.

Soft Keys

These keys directly correlate to the 5 selection boxes located at the bottom of the main display. These are also used in the info/option menus to select options.

Warning Sound Controller

Warning Bell and Variable Horn control. Pull down to sound Horn. Push up and release to trigger Warning Bell.

Multi Controller

Boost, Brake, and Direction control. Rock forward for Boost, rock backward for engine brake, and press down for direction change. Click-hold-and rock for absolute direction selection.

Front & Rear Coupler Buttons

Fire couplers.

Feedback Button

Toggle ON/OFF the vibration feedback feature in the CAB-2 Remote.

Official R.R. Speed Control Bar

Toggles the touchscreen display of R.R. preset speeds and control panel.

Low, Medium, High Momentum Buttons

Used to select the desired momentum of your addressed engine/train/accessory.

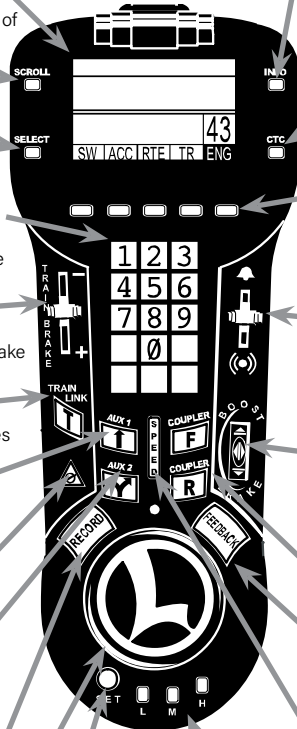

LEGACY Control System operations

Note! This section is a brief overview of the LEGACY Control System. For a more in-depth explanation of the LEGACY Control System features, please see your LEGACY Control System Operations Manual, available online at www.lionel.com.

The Velocity Throttle

The Velocity Throttle (the red rotary knob on the bottom of your Lionel remote) is used to start your engine moving, slow it down, or speed it up. Use it simply by turning it clockwise (speed up) or counter-clockwise (slow down).



The Multi-Controller

Direction

The direction of your engine toggles between forward and reverse at the touch of the Multi-Controller. Press the center of the Multi-Controller once, and your engine's lights will change directions and the engine will stop until you throttle up again in the new direction.

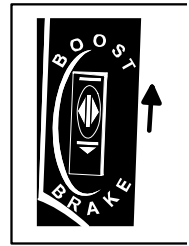

Boost & Brake

Boost and brake give you another way to control the speed of your train. Boost gives your loco a temporary increase in tractive power, and returns to the previous speed when you release the control, while the brake command slows you down more quickly than the Velocity Throttle alone.

The Train Brake Slider

The Train Brake is used to slow down and limit the top speed of your train by adding a load. The more the Train Brake is applied by pulling the Train Brake Slider down, the more laboring is heard from the engine. Eventually Train Brake application will slow down the train and it is even possible to stop a train by pulling the Train Brake Slider all the way down. If your smoke unit is turned on, you'll also see more smoke as the slider is pulled down.

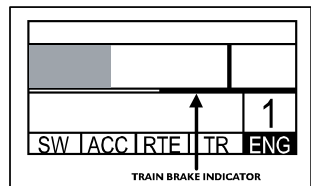
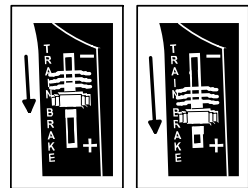

LEGACY Control System operations

The Warning Sound Controller

Warning sounds are an important part of Lionel Railroading. Your Lionel Legacy Control System equipped engines have a real-time variable "quilling" horn.

Blow the Horn by pulling down on the Warning Sound Controller. Notice the difference in intensity of the horn sound.

Strike the bell once by pushing the Warning Sound Controller up and releasing quickly. To activate continuous bell sounds, push the Warning Sound Controller up and hold it for 1.5 seconds. To discontinue the bell sounds, push and hold the Warning Sound Controller up until the bell stops.

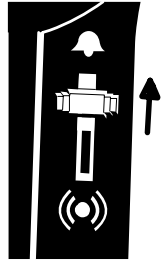

Note! Your engine is equipped with 5 different horns or whistles and 5 different pitch levels for the bell! Press Aux1 and pull the Warning Sound Controller down to change the horn or whistle. Press Aux1 and then push the slider up to change the bell pitch.

The Speed Bar

The Speed Bar is used to select a new touch-screen Icon Control set. This set of touch-screen keys is used to select prototypical preset speeds. The speed of the engine changes with each press and release of a different Preset Speed key.

- Tap a key, and your locomotive will immediately begin moving to that speed.
- If you hold the key until the dialogue is finished, the engineer will indicate that he is "increasing to...", "slowing to...", or "we are at..." the command speed.

You can also use the Velocity Throttle and other action controls in this mode and continue to use Preset speeds at the same time.

Press **AUX1** to leave the Preset speed mode and return to the Standard Control Panel. Press the speed bar to toggle between the Speed Control Panel and the Standard Control Panel.

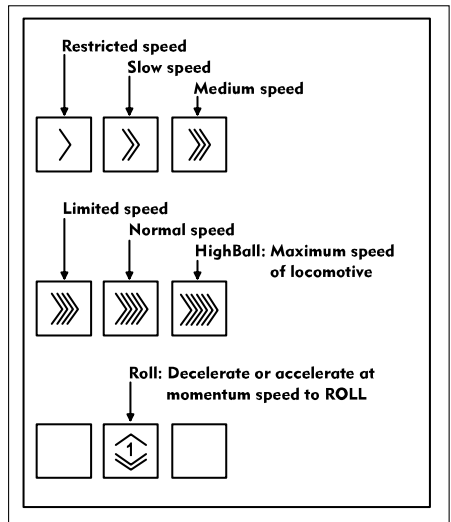

Note! Switcher engines do not have preset speed dialogue.

LEGACY Control System operations

EFX Trim and EFX Bar Graph

Sound and smoke effects of the engine can be trimmed higher or lower depending on your operating preference. Pressing the EFX up button will make the engine sound like it is working harder and will also increase the smoke output (if the smoke unit is turned on). Similarly, the EFX down button will decrease the laboring sound of the engine and smoke. A RESET command will return the EFX trim to its default setting.

Notice that the current EFX level is displayed on the remote as a bar graph inside the soft key to the left of the ROLL button. The height of this graph varies with the EFX keys, throttle and train brake adjustments.

Leaving the Preset Speed Screen

Use the Speed Bar to leave the Speed Panel and return to the Control panel. Press the Speed Bar to toggle between the Speed Control Panel and the Standard Control Panel.

LEGACY RailSounds sound system operations

LEGACY RailSounds sound system

Volume UP

Raises the overall master volume of the LEGACY RailSounds sound system. To independently adjust the level of the background sounds only (e.g., the diesel roar and brake sounds), tap AUX1 and then this key.

CrewTalk

Engineer begins radio dialogue, dispatcher replies.

RPM Levels

Adjusts the level of the RPM sounds.

Volume DOWN

Lowest the overall master volume of the LEGACY RailSounds sound system. To independently adjust the level of the background sounds only (e.g., diesel roar and brakes), tap AUX1 and then this key. Volume settings are retaining when track power is turned off.

RailSounds Shutdown

Activates the LEGACY RailSounds sound system shutdown sequence when stopped.

Emergency Stop

Activates the emergency stop feature while in motion. (Icon will change as the state of the locomotive changes).

Rule 17 Lighting

Use the Rule 17 buttons to turn the Rule 17 lighting functionality (e.g., headlights dim at a stop) on and off.

TrainSounds Dialog

Activates dialog of random radio chatter.

Activate the "Special Sound".

Stops and resets the locomotive

Resets the locomotive's direction to forward. Press and hold to activate a fueling sequence. Fueling sounds.

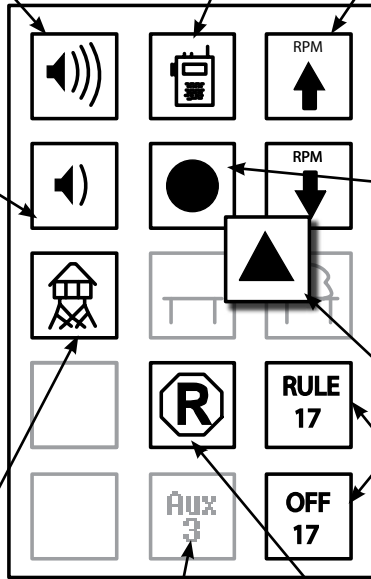

When adjusting the overall volume, you'll hear a single bell hit that gets louder or softer with each volume adjustment. When the volume is at maximum, additional button presses have no effect and won't play the bell. When adjusting the background sounds (AUX1, then a volume key) you'll hear the prime mover volume change without a single bell hit.

LEGACY RailSounds sound system operations

LEGACY RailSounds Sequence Control

Your LEGACY-equipped locomotive set features Sequence Control. Based on the movement and speed of the locomotive set, Sequence Control automatically plays the sound effects of an entire trip, from departure to destination, while you run your locomotive set. Prototypical horn signals, bell, and radio chatter are added automatically as you spin your throttle—no need to memorize a sequence of button presses.

To activate the Sequence Control feature, press and hold the **AUX1** button for three seconds. You'll hear a unique bell/horn signal, indicating that Sequence Control is now enabled. Release the **AUX1** key when you hear the sound.

Now, radio chatter, air brake release, and warning signals will play automatically as you move out, reach cruising speed, and then decelerate for arrival, as illustrated in Figure 5. Plus, you can still activate CrewTalk communication and TowerCom announcements using your remote.

To discontinue Sequence Control, you must tap **AUX1**, and then tap the **0** key or the **RESET** button. Cycling track power off and back on also turns off Sequence Control mode.

Note! During sequence control mode operation, speed step 1 is used to trigger departure effects such as air brake release and departure horn. Therefore your engine will not begin moving until speed step 2 and the Roll Mode button will bring your engine to a stop while Sequence Control mode is enabled. For the most realistic operation, medium or high momentum is recommended when using Sequence Control.

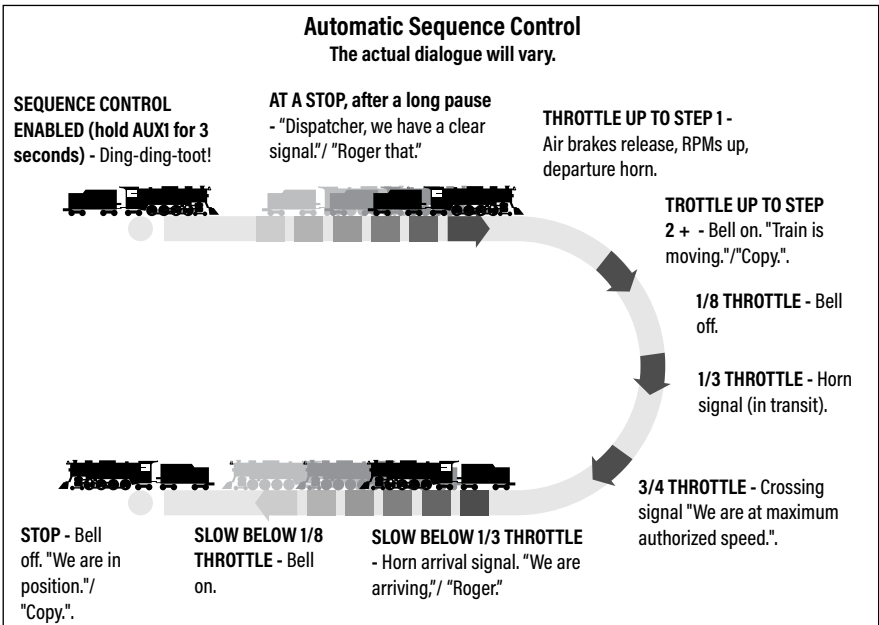

Figure 5. LEGACY RailSounds automatic Sequence Control

LEGACY Control System operations

CrewTalk dialog in the LEGACY environment

In addition to the automatic triggering of dialog via Sequence Control mode operation (see the previous section), you may control the dialog manually.

CrewTalk dialog features a variety of brief radio conversations between the engineer and dispatcher. CrewTalk dialog is an engineer-initiated radio conversation with the dispatcher. Be sure to listen for the different combinations of words and phrases that comprise these exchanges. TrainSounds dialog adds a fun variety to your train's available sounds. In diesels, you'll hear randomized realistic radio chatter. In steam, you'll hear maintenance crews or cab chatter depending on the state of engine.

Refer to Table 1 below for the dialog commands. The dialog in the table provides examples of the conversations you can trigger. The actual dialog will vary.

Locomotive	Commands	Example dialog
Stopped	AUX1, 2	Crew: Fuel level
	2	Crew: Ask to depart Tower: Deny departure
	2	Crew: Ask to depart Tower: Approve departure
	5 or AUX1, 5	Crew: Shutdown Announcement
	Reset or AUX1, 0 (hold for several seconds)	Refueling sequence Crew: My fuel is full
	7	TrainSounds Dialog: Randomized radio chatter
Moving	AUX1, 2	Crew: Report speed
	2	Crew: Are we clear ahead? Tower: Acknowledge
	2	Crew: Are we clear inbound? Tower: Acknowledge
	5 or AUX1, 5	Tower: Emergency stop Crew: Acknowledge
	7	TrainSounds dialog: Randomized radio chatter

Table 1. LEGACY Remote Controller dialog commands

Using the LionChief App

Note! Available for both Apple and Android small hand-held smart devices.



Note! When running in Bluetooth mode with either the LionChief Universal Remote or the LionChief App, the lead A-unit must be controlled for the trailing A-unit to also be controlled. A trailing A-Unit will not run by itself via Bluetooth control.

Connecting your Bluetooth-equipped locomotive on Apple devices

Once you have downloaded the free LionChief app and your locomotive is powered up on the track, tap the LionChief icon on your Apple smart device.

The screens below will be present and within a few seconds will automatically connect with your locomotive. Once it has connected, your Bluetooth enabled locomotive will show up in the locomotive box. You are now ready to operate your locomotive.

Note! A Legacy or LionChief Plus 2.0 Bluetooth-equipped engine will blow the horn/whistle once when it has connected to a Bluetooth device. All others will make a chirping sound until connected.



Figure 6a. LionChief app home screen prior to connecting to an engine

Figure 6b. LionChief app home screen when a locomotive is connected



What if my Bluetooth enabled engine didn't automatically connect?

Tap on the locomotive road number (1234 when no engine is connected). The engine select screen will appear as shown below. Tap on the engine you wish to connect to, and then tap on the Link button to connect. The app will automatically return to the home screen.

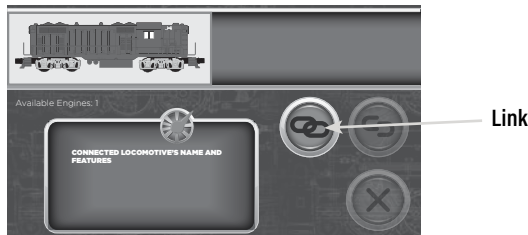

Figure 7. Engine Select screen

Using the LionChief App

Connecting your Bluetooth-equipped locomotive on Android devices

Once you have downloaded the free LionChief app and your locomotive is powered up on the track, tap the LionChief icon on your Android smart device.

The home screen below will appear. Tap on the locomotive road number (1234 when no engine is connected). Once on the Engine Select screen, tap on the looking glass icon to search for available engines. Once engines appear, tap on the one you wish to connect to and tap on the link button. Finally, tap on the X button to return to the app home screen.

Note! A Legacy or LionChief Plus 2.0 Bluetooth-equipped engine will blow the horn/whistle once when it has connected to a Bluetooth device. All others will make a chirping sound until connected.



Figure 8a. App home screen prior to connecting to an engine



Figure 8b. Engine Select screen prior to searching for an engine



Figure 8c. Engine Select screen after finding an available engine

Using the LionChiefApp

Running your locomotive

This is your main control panel.

Note! Grayed out icons means this feature is not available on your locomotive.

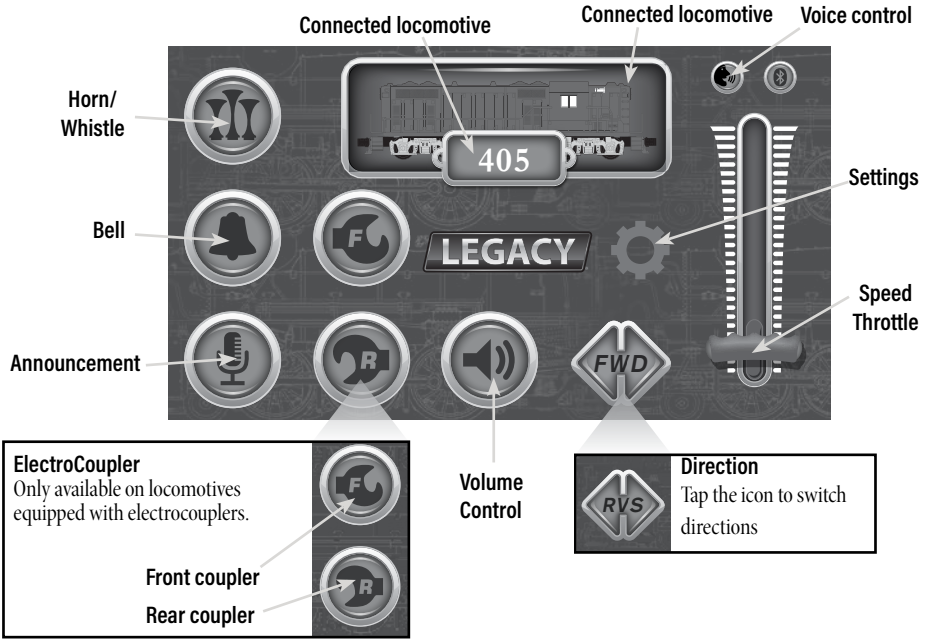

Figure 9. Controlling your locomotive with the app

Using the LionChiefApp

Settings

On the setting screen, you will be able to establish key elements of how your locomotive will run including smoke, momentum and speed limit. These settings will reset once you are done running the locomotive and close out of your LionChief app.

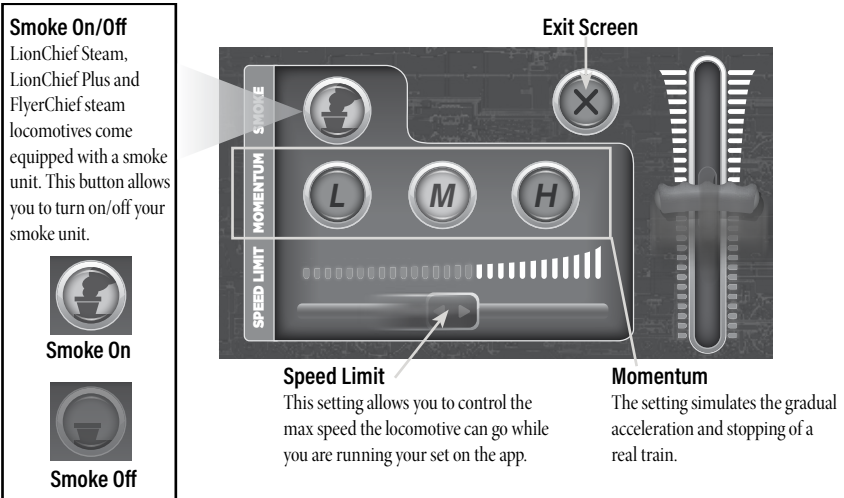

Figure 10. Adjusting locomotive speed and smoke settings

Volume Settings

Lionel Bluetooth-equipped engines come with a very impressive RailSounds sound system. This menu in the app allows you to establish the volume for individual sound elements or the overall sound level.

Note! Once these are established here, the characteristics will continue both on the app or with your remote until you choose to change them again.

Pitch

You are able to adjust the quality of sound "higher" or "lower" for both the horn/whistle and bell.

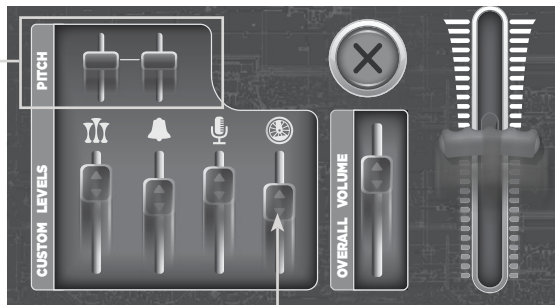

Figure 11. Adjusting locomotive individual and overall volume levels

Note! On newer Legacy models, the horn/whistle pitch slider may change the type of whistle/horn altogether!

Using the LionChief App

Switching Connection Between Multiple Bluetooth® Locomotives

Your LionChief app will display all “available” locomotives in the engine selection carousel. If you have three or more available engines, touch and scroll right to view them. Switching between available locomotives is easy, press the un-link icon to release the currently connected engine. Alternately, you can highlight the engine you would like to run and press the Link icon to connect. In both cases, if the previously selected locomotive was in motion, it will stop when disconnected.

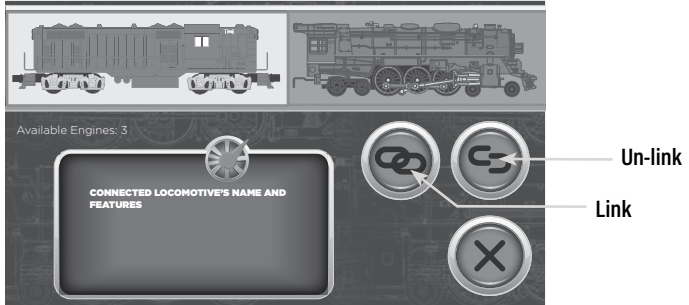

Figure 12. Switching between three locomotives

Using the LionChief App

Lionel Voice Control

The LionChief app now features voice control for Bluetooth-equipped trains! To use voice control, a Bluetooth-equipped engine must first be connected to the app. Once connected and on the app's home screen, tap on the LVC icon as shown below.



Figure 13. LVC button location on the app's home screen

The voice command prompt will appear and indicate that it's ready for you to speak! Try saying different commands to make your engine do as you wish!



Figure 14. Lionel Voice Control prompt

The chart on the next page shows some of the basic commands that the app will recognize. While the app is capable of recognizing many more commands than what is in the chart, this will get you started by using Lionel Voice Control's basic functions.

Using the LionChiefApp

Lionel Voice Control continued

For this feature...	Say these words...
Throttle	
Stop	Stop, Emergency Stop
Slow Speed	Slow Speed, Low Speed, Low Throttle
Medium Speed	Medium Speed, Medium Throttle
Fast Speed	High Speed, Fast Speed, Highball, Full Throttle
Direction change + Slow Speed	Go Forward, Move Forward
Direction change + Slow Speed	Go Backward, Back Up
Increase Speed	Speed Up, Increase Speed, Go Faster, Accelerate
Decrease Speed	Slow Down, Decrease Speed, Go Slower, Decelerate
Direction	
Forward	Forward, Forward Direction
Reverse	Reverse, Reverse Direction, Backwards
Toggle	Direction, Change Direction, Other Way, Switch Direction
Volume	
Mute	Mute, Volume Off, Quiet
Low Volume	Low Volume, Volume Low, Minimum Volume
Medium Volume	Medium Volume, Volume Medium, Medium Sound
High Volume	High Volume, Max Volume, Full Volume
Dialog	Dialog, Speech, Speak, Talk, Crew Talk
Coupler	
Front Coupler	Front Coupler, Front Connector
Rear Coupler	Rear Coupler, Rear Connector
Bell	
Bell On	Bell On
Bell Off	Bell Off
Horn/Whistle	Horn, Whistle, Blow Horn, Blow Whistle
Smoke	
Smoke On	Smoke On
Smoke Off	Smoke Off, No Smoke
Other	
Disconnect	Disconnect
Help	Help

Table 2. Lionel Voice Control basic command functions

Note!

If you are trying to figure out more commands to use with Lionel Voice Control, say “help” to the app and an in-app dialogue box will appear showing additional available commands.

Using the LionChiefApp

Troubleshooting

- If the locomotive does not appear in the App's "engine selection carousel," try turning the track power off, wait 5 seconds and turn it back on. If that still doesn't work, try restarting the app on your device.
- If a universal remote is present and powered on, make sure one of its 3 channels is not connecting to your locomotive before the app is able to connect.
- Make sure that your smart device's Bluetooth is turned on. This is done outside of the LionChief app.
- If equipped, check the engine's Bluetooth ON/OFF switch and switch it to the ON position.
- For more Voice Control options, say "help" for a list of basic commands.

Note!

Legacy and LionChief Plus 2.0 locomotives can receive commands from both a Bluetooth and TMCC controller at the same time.

Using the LionChief Universal Remote

The LionChief Universal Remote (6-83071)

Note! Please refer to your *LionChief Universal Remote manual* for in-depth details of operation.

Note! When running in Bluetooth mode with either the LionChief Universal Remote or the LionChief App, the lead A-unit must be controlled for the trailing A-unit to also be controlled. A trailing A-Unit will not run by itself via Bluetooth control.

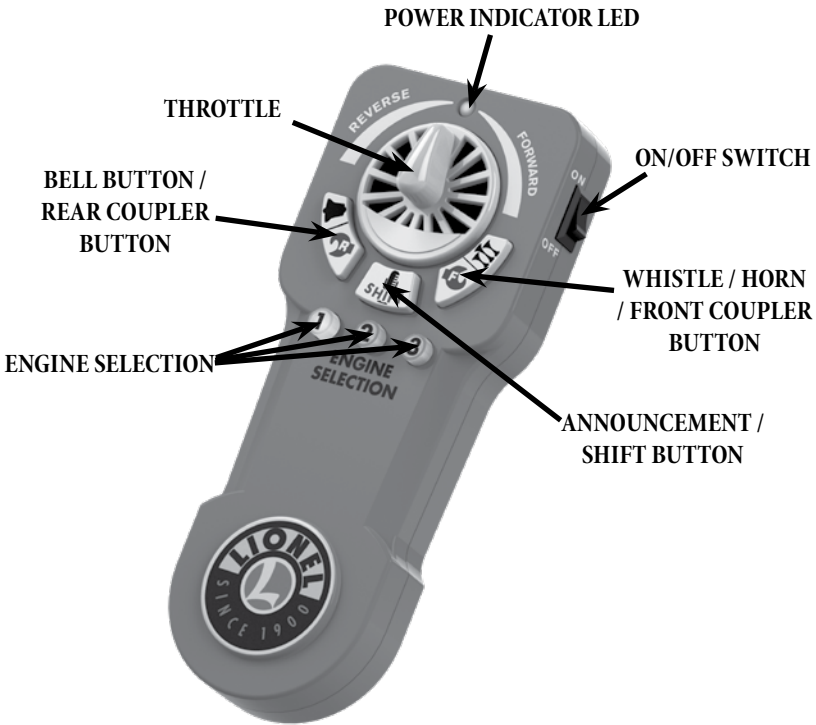

POWER INDICATOR LED

When solidly illuminated, this red LED indicates the remote is turned on. When the remote pairs with a locomotive it will visually reflect the speed on the locomotive; solidly illuminated for idle, slow to fast blink, based on the speed of the locomotive. If the LED does not illuminate when the remote is switched on, the batteries need to be replaced.

ANNOUNCEMENT / SHIFT BUTTON

Press and release the announcement button to activate the locomotive's announcements. Press and hold the Announcement button for it to function as a "shift key".

Using the LionChief Universal Remote

The LionChief Universal Remote continued

ON/OFF SWITCH

Use this switch to turn the Universal Remote on and off. We recommend you turn the remote off when not in use to conserve battery life.

WHISTLE / HORN / FRONT COUPLER BUTTON

Press the Whistle / Horn button to activate the horn / whistle. To activate the front coil coupler on the locomotive press and hold the Announcement button down and, using another finger, press and release the Whistle/Horn button to activate the front coupler. Then release the Announcement/Shift button.

BELL BUTTON / REAR COUPLER BUTTON

To turn the bell on, press the bell button one time. To turn the bell off press the button again. To activate the rear coil coupler on the locomotive press and hold the Announcement button and, using another finger, press and release the Bell button to activate the rear coupler. Then release the Announcement/Shift button.

ENGINE SELECTION

1, 2, 3

Each Engine Selection button represents a channel for controlling one LionChief, LionChief Plus, or Legacy Bluetooth locomotive. Each of these buttons may be “paired” with a different locomotive. Once paired, you can control multiple locomotives from one remote by pressing an Engine Selection button, then using the throttle, horn, bell, etc..

Note! Your remote will remember all locomotive pairings when you turn everything back on for your next operating session.

THROTTLE

Turn the throttle clockwise slowly to increase speed in the forward direction. Returning the throttle to the top dead center position will bring the locomotive to a stop. Moving the throttle counterclockwise will increase the speed of the locomotive in reverse. The Throttle also functions as the volume control for LionChief Plus locomotives. Refer to “Adjusting the locomotive volume” section in this manual for more detailed information.

Using the LionChief Universal Remote

Adjusting the locomotive volume with the Universal Remote

This feature, is only available for LionChief Plus and Legacy locomotives. To adjust the overall volume of the locomotive's sound system begin by placing the throttle in the top dead center position (so the red LED is solidly illuminated and the locomotive is stopped). Press and hold the Announcement button then turn the throttle to the left and / or right, this will increase and decrease the overall locomotive volume. Continue holding the Announcement button when turning the throttle, you can stay in this mode until the volume is at the level you desire. Once the volume level is set to the level you want release the Announcement button and return the locomotive throttle to the top dead center position again. (The new volume level will remain until you change it in the future, even after power has been cycled.) If, after running the locomotive, you decide to change the volume, simply follow the steps above to do so.

Note!

If the throttle is not in the top dead center position before or after the volume adjustment process undesired operation will occur. Always start and finish the volume adjustment process with the throttle in the top dead center position!

Pairing locomotives to the Universal Remote

Your Universal Remote can connect or "pair" to one, two or three different locomotives at a time. Each "target" locomotive will be associated with one Engine Selection Button. Once you've paired with a locomotive, you can run it.

However, only "available" locomotives can be paired with the Universal Remote. "Available" means "not currently controlled by any other remote." An available locomotive will be powered up and beeping or chirping (older LionChief locomotives will play locomotive background sounds when available).

To Pair a Locomotive to Engine Selection button #1

1. Turn on power to your Universal Remote
2. Press and hold Engine Selection button #1 until it blinks rapidly. This will clear any previously stored pairing information so you can connect to the new target locomotive.
3. Release the button. It should flash slowly, indicating it is not connected to a locomotive.
4. Place the target locomotive on the track and apply track power.
5. Tap and release Engine Selection button #1. The remote will now seek and connect to the first available locomotive it finds.
6. Engine Selection button #1 should now be on (no flashing) and if the locomotive was beeping or chirping, it should now be playing engine background sounds.
7. Run the locomotive!

This locomotive pairing is now stored in your Universal Remote. The next time this engine and remote are powered on, the connection will be automatically re-established.

To Pair a Locomotive to Engine Selection buttons 2 or 3, simply follow the same steps with the other two Engine Selection Buttons.

Note!

Legacy locomotives cannot be operated by the Universal Remote if they are already under the control of the App or another Universal Remote.

Using the LionChief Universal Remote

Operating locomotives with the Universal Remote

Now that you have paired locomotives with the Universal Remote its time to run trains! Operation with the Universal Remote is very similar to using the basic remote included with your locomotive. Switch between the locomotives you want to control by pressing different Engine Selection buttons.

Using the Throttle with multiple locomotives

Familiarize yourself with the Universal Remote by putting just one locomotive in motion at a time. Once you are comfortable as to which button is paired to what locomotive, try putting multiple locomotives in motion using the Universal Remote.

As soon as you press a different Engine Selection button, you can command the newly selected engine to blow its whistle, ring the bell or trigger dialogue. However, throttle control does not automatically switch!

To take throttle-control of the selected engine, you have two choices: You can make the locomotive match the remote's current throttle position—or—you can change your remote's throttle position to match the engine's current speed and direction.

To immediately force the engine to match the throttle, just press that Engine Selection button a second time. The locomotive will immediately honor the current position of your throttle. This may result in an abrupt change in speed and/or direction.

Option two will avoid the possibility of an abrupt speed change. After pressing the Engine Selection button once, manually turn your throttle knob until it matches the locomotive's current speed and direction. Once you've matched the knob position, the main red LED will begin flashing at a rate proportional to the engine's speed. From this point on, further throttle rotation will change the engine's speed and/or direction.

Here's an example showing the "throttle matching" option in action.

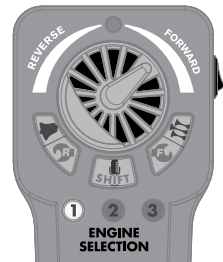

Engine #1 (above) is a diesel with throttle set for forward direction, medium speed.

Using the LionChief Universal Remote

Operating locomotives with the Universal Remote continued

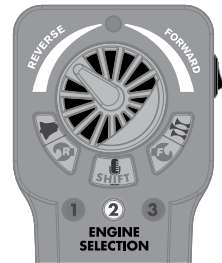

Engine 2 (above) is a steamer at stop. Press Engine Selection button #2 and turn the throttle counter-clockwise through the 12 o'clock (stop) position and continue to put this loco in reverse at slow speed. Meanwhile, notice that engine #1 is still moving forward as before.

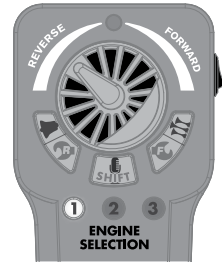

Now, switch back to engine #1, the diesel. Note that even though the throttle is in the reverse/slow speed position, the diesel continues moving forward at medium speed.

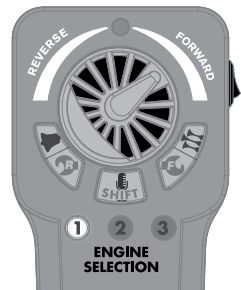
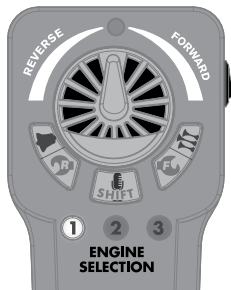
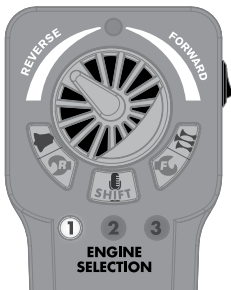

Match!

To regain speed and direction control over diesel locomotive #1, you must match the throttle position to the engine's current speed and direction. Turn the throttle clockwise. Once you've matched the throttle position, additional throttle adjustments will again cause speed and direction changes of the currently selected engine.

TrainMaster Command Control operations

CAB-1 Remote Controller commands

The CAB-1 Remote Controller commands are detailed below. *The corresponding RailSounds sound system effects are in italic type.*

 Releases the ElectroCoupler on the front of the Powered locomotive. *Coupler release sound.*

 Releases the ElectroCoupler on the front of the Helper locomotive.

 Activates the numeric keypad. *Short air release sound.*

 Controls switch direction. Toggles all lights on/off, except lights that are wired to track power.

 Accelerates the locomotive set with a clockwise rotation. Decelerates the locomotive set with a counter-clockwise rotation. *Speed-dependent RPM sounds.*

 Activates the locomotive set's horn. Release the button to discontinue the sound. *Horn sound.*

 Toggles the bell sound on and off. *Bell sound.*

 Changes the locomotive set's direction. The locomotive set decelerates to a stop and continues in the opposite direction when you increase the throttle. *Air release sound.*

 Increases the locomotive set's speed while the button is pressed. Release the button to return to the initial speed. *Labored prime mover.*

 Decreases the locomotive set's speed while the button is pressed. *Squealing brake sounds.*

 Shuts down all PowerMasters on your railroad. Stops all TrainMaster Command Control-equipped locomotive sets in operation. Use HALT only in emergency situations.



Odyssey II Momentum

- L** 32 speed steps with low momentum
- M** 100 speed steps with low momentum
- H** 100 speed steps with medium momentum

TrainMaster Command Control operations

CAB-1 Remote Controller numeric keypad commands

When you press the **AUX1** button on your CAB-1 Remote Controller, you turn the numeric keypad into ten command buttons. After you press the **AUX1** button, you will be able to press any numbered button until you address a different product. *The corresponding RailSounds sound system effects are in italic type.*



Stops and resets the locomotive set. Resets the locomotive set's direction to forward. Your locomotive set keeps track of its fuel level. Higher engine speeds and/or heavy labor will use fuel at a faster rate. Press and hold **AUX1, 0** for at least 3 seconds. You will hear the sounds of fuel flowing into the tank as long as you hold the button. When you release the button, the sounds will stop and the engineer will confirm that the tank is full. *Refueling sequence.*



Raises the overall master volume of the LEGACY RailSounds sound system. To independently adjust the level of the background sounds only (e.g., the diesel roar and brake sounds), tap **AUX1** and then this key. *Sound volume increases.*

When adjusting the overall volume, you'll hear a single bell hit that gets louder or softer with each volume adjustment. When the volume is at maximum, additional button presses have no effect and won't play the bell. When adjusting the background sounds (**AUX1**, then a volume key) you'll hear the prime mover volume change without a single bell hit.



Engineer begins radio dialogue, dispatcher replies (see page 19). *CrewTalk communication.*



Enters manual RPM mode and increases the RailSounds sound system RPM level. If the LEGACY RailSounds sound system is shut down (see **5** key below), **3** activates a full LEGACY RailSounds sound system start-up while the locomotive is stopped after pressing **5** with track power on.

TrainMaster Command Control operations

CAB-1 Remote Controller numeric keypad commands (continued)



Lowers the overall master volume of the LEGACY RailSounds sound system. To independently adjust the level of the background sounds only (e.g., diesel roar and brakes), tap **AUX1** and then this key. Volume settings are retained when track power is turned off. *Sound volume decreases.*



Activates the LEGACY RailSounds sound system shutdown sequence when stopped. Activates the emergency stop feature while in motion. Note that, in the shutdown sequence, the smoke unit will turn off if it was already on.



Enters manual RPM mode and lowers the LEGACY RailSounds diesel motor RPM level.



TrainSounds random radio chatter.



Turns off the smoke units. *Air release sound.*



Turns on the smoke unit if the smoke unit switch is in the ON position. Be sure to add smoke fluid before turning on the smoke unit to prevent damage to your locomotive set. *Air release sound.*

Note! 8 and 9 function only if the locomotive set's smoke unit switch is in the ON position.

Setting the smoke level

You may adjust the level of smoke production using your Remote. Use the sequences below.

If the smoke unit is off, press the **9** key to turn the smoke unit on for **LOW** smoke production. Press again for **MEDIUM** smoke, and lastly one more press for **HIGH** smoke production. The **8** key can then be used to turn the smoke production back down and then off.

Conventional transformer operations

Using the LEGACY RailSounds sound system in the conventional environment

When you first power up your locomotive set, you will hear the sounds of the locomotive set at rest. As the locomotive set moves, the RPM sounds automatically increase with the locomotive set's speed. In the conventional environment, the horn and bell sounds are activated by your transformer controls, if so equipped.

In the conventional environment, you will experience several features of the LEGACY RailSounds sound system.

- **Diesel motor RPM levels.** The level of diesel motor RPM level automatically varies with the speed of the locomotive set.
- **MultiHorn.** A different horn sound at different speeds.
- **Mechanical bell.** Press BELL on your transformer to begin the effect, then press BELL a second time to discontinue the effect.
- **CrewTalk dialogue.** These brief conversations between the train crew and the tower are triggered by short horn blasts.

Locking your locomotive set into a single direction

When the program-run switch is in the RUN position, your locomotive set sequences through a repeating pattern of operations: forward, neutral, reverse, neutral, and so on.

To “lock” your locomotive set into a single direction (for example, to operate in forward only), you can deactivate the Command reverse unit's sequencing function.

1. **Use your transformer's DIRECTION button or interruptions in track power to get your locomotive set moving slowly in the desired direction or into neutral.**
2. **Slide the program-run switch on the lead A-unit to the PGM position. At this point, the locomotive is “locked” into your chosen direction. See Figure 4a on page 10 for the location of this switch.**

To restore the forward-neutral-reverse sequence, just slide the program-run switch back to the RUN position.

Maintaining and servicing your locomotive set

Reprogramming your locomotive set to restore features

If your locomotive set is unresponsive to your commands in the Command Control environment, we recommend that you follow this procedure to reset your locomotive set. All factory default settings will be restored when you reprogram the locomotive set.

Note! Work with only one locomotive at a time. Do not attempt to reprogram both units simultaneously.

1. Slide the Program-Run switch to the PGM position.
2. Plug in and connect your LEGACY Base.
3. Place your locomotive set on the track, then power up the track. *Reprogram only one unit at a time.*
4. Press ENG and enter the locomotive set's ID#.
5. Press SET.
6. Press and hold the RESET button (or 0) until you hear a single bell ding. This may take up to 10 seconds.
7. Slide the program run switch back to the RUN position.

At this point, your locomotive set has been reset to factory defaults. Use TMCC ID #1 to control it, or reprogram the engine to the desired TMCC ID#.

Maintaining and servicing your locomotive set

Lubricating your locomotive set

Help your Lionel locomotive set lead a long and productive life on your railroad by maintaining it properly. To keep your locomotive set lubricated, we recommend that you purchase a Lionel Lubrication and Maintenance Kit (6-62927), available from your authorized Lionel dealer.

When you find that the lubrication points illustrated in Figure 15 appear dry, lubricate your locomotive set after you have removed any accumulated dirt and dust. There are two basic rules to keep in mind when you are lubricating your locomotive set: use only a small amount of lubrication and avoid getting grease or oil on your locomotive set's wheels, roller pick-ups, or the track.

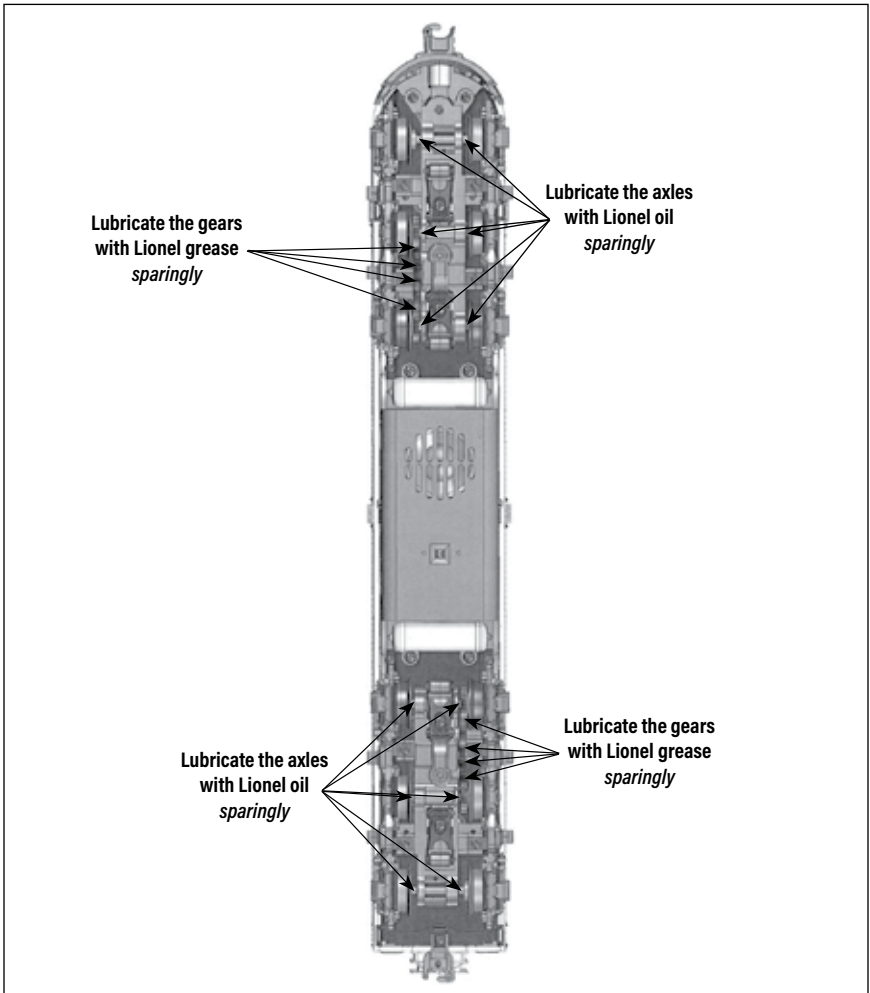

Figure 15. Lubricating both the lead A-unit and the trailing A-unit

Maintaining and servicing your locomotive set

Servicing your locomotive set's LEDs

Note! If the locomotive set is powered up and the lights are not on, check that the **AUX2** command was not used to turn the lamps off.

Your locomotive set is illuminated by several LEDs that are expected to last for the life of the locomotive set. The LEDs are not user serviceable. If service is required, we recommend that you have your locomotive set serviced at a Lionel Factory Trained Authorized Service Station or Lionel Service.

Replacing the traction tires

Your locomotive set is equipped with traction tires to increase the tractive effort of your locomotive set and allow it to pull more cars at once.

During the course of normal operations, the traction tires may become worn out. To replace the traction tires, remove the side frame screws from the underside of the trucks and lift away the side frame. Remove the worn tire, then slip the replacement around the wheel. Reposition the side frame on the truck and secure it with the two screws.

Locomotive set diagnostics

Your locomotive set includes built-in diagnostics to monitor the condition of the main drive motor. If a problem is detected, the locomotive set's cab light will blink a diagnostic code.

If you see the light inside the cab flashing, press **RESET** (for LEGACY operation), **0** (for TMCC operation), or **DIRECTION**/power interruption (for conventional operation to attempt to clear the problem). The locomotive set will immediately check itself again. If the problem persists, the cab light will blink the code again.

Number of Blinks	Diagnostic Code Description
1	Main drive motor stalled.

Lionel Limited Warranty Policy & Service

This Lionel product, including all mechanical and electrical components, moving parts, motors and structural components, with the exception of **TRACTION TIRES** are warranted to the original owner-purchaser for a period of **one year from the original date of purchase** against original defects in materials or workmanship when purchased through a **Lionel Authorized Retailer***.

This warranty does **NOT** cover the following:

- Normal wear and tear
- Defects appearing in the course of commercial use
- Damage resulting from abuse/misuse of the product
- Damage resulting from consumer or unauthorized attempted repair or modification

Transfer of this product by the original owner-purchaser to another person voids this warranty in its entirety. Modification of this product in any way; visually, mechanically or electronically, voids the warranty in its entirety.

Any warranted product which is defective in original materials or workmanship and is delivered by the **original owner-purchaser** (this warranty is non-transferrable) to Lionel LLC **MUST** be accompanied by the original receipt for purchase (or copy) from an **Authorized Lionel Retailer***, will at the discretion of Lionel LLC, be repaired or replaced, without charge for parts or labor. In the event the defective product cannot be repaired, and a suitable replacement is not available, Lionel will offer to replace the product with a comparable model (**determined by Lionel LLC**), if available. In the event a comparable model is not available the customer will be refunded the original purchase price (requires proof of purchase from the **Authorized Lionel Retailer*** it was originally purchased). Any products on which warranty service is sought must be sent with prior Return Authorization # from Lionel freight or postage prepaid (Lionel will refuse any package when postage is due). Lionel is not responsible for any unauthorized contents of the package or shipping packaging or materials or any package sent with-out prior authorization. **Transportation and shipping charges are not covered as part of this warranty for international shipments.**

NOTE: Products that require service that do not have a receipt will not be serviced by Lionel. Any product sent to Lionel under a Return Authorization and not accompanied by a receipt; the return shipping costs will be the responsibility of the customer.

In no event shall Lionel LLC be held liable for incidental or consequential damages.

Some states do not allow the exclusion or limitation of incidental or consequential damages, so the above exclusion may not apply to you. This warranty gives you specific legal rights and you may have other rights which vary from state to state.

Instructions for Obtaining Service

If service for this Lionel LLC product is required you must **FIRST** call 1-800-4LIONEL (1-800-454-6635), Email Talktous@lionel.com, or write to Lionel Customer Service, 6301 Performance Drive, Concord, NC 28027. Please have the Lionel product number and original receipt showing the date, location of original purchase, and description of problem. You will receive a return authorization (RA) number to ensure your merchandise will be properly tracked and handled upon receipt at Lionel LLC.

Once you have your Return Authorization (RA) number, make sure the item is well packed to protect during shipping. (The original packaging was designed to protect product during transit).

Please make sure you have followed all of the above instructions carefully before returning any merchandise for service.

Warranty Information

Products that are more than 3 years old, from date of manufacture, are not applicable for warranty coverage, even if they have never been sold prior to this date. (Under no circumstance shall any components or labor be provided free of charge.)



©2023 LIONEL L.L.C.
6301 Performance Dr., CONCORD, NC 28027
UNITED STATES OF AMERICA
PRINTED IN CHINA